



Owner's Manual

***Model 1838 Access Plus
PC Programmable Access Control System***

DoorKing, Inc.
120 Glasgow Avenue
Inglewood, California 90301
U.S.A.
Phone: 310-645-0023
Fax: 310-641-1586
www.doorking.com

Use this manual with the following models only.

1838 Access Plus Access Control System with circuit board 1970-010.

DoorKing, Inc. reserves the right to make changes in the products described in this manual without notice and without obligation of DoorKing, Inc. to notify any persons of any such revisions or changes. Additionally, DoorKing, Inc. makes no representations or warranties with respect to this manual. This manual is copyrighted, all rights reserved. No portion of this manual may be copied, reproduced, translated, or reduced to any electronic medium without prior written consent from DoorKing, Inc.

Table of Contents

Preface

Important Notices.....	6
General Information.....	7
Features	8

Section 1 – Installation & Wiring

Installation Guidelines	
1.1	Mount the 1838 Access Plus.....9
1.2	Dimensions.....10
1.3	Power Wiring Information.....11
1.4	Surge Suppression and Grounding.....11
1.5	Telephone Line Wiring.....12
1.6	Terminal Identification / Main Terminal Wiring.....13
1.7	RS-485 Wiring.....14
1.8	Network Connections.....15
	Direct Connection Using a Crossover Cable.....16
	Direct Connection Using a Router (LAN).....16
	Connection through the Internet.....17
	Connection via a Modem.....18

Section 2 – Programming

2.1	Programming the Master Code.....19
2.2	Programming Methods.....20
2.3	Programming with a Computer
2.3.1	Enable / Disable TCP / IP Support – System Reboot.....21
2.3.2	Set the 1812 IP Address.....21
2.3.3	Sub-Net Mask.....22
2.3.4	Set the Gateway (router) IP Address.....22
2.3.5	Set the Port Number.....22
2.4	System Parameters – Programming via Keypad / Touch-Tone telephone.....23
	Programming Reference Table.....24
2.4.1	Relay Strike Time.....25
2.4.2	Tone Open Numbers.....25
2.4.3	Answer Incoming Calls on X Rings.....26
2.5	Devices
2.5.1	Number of RS-485 Devices.....27
2.5.2	RS-485 Device Off-line Function.....27
2.5.3	Device Access Code Programming.....28
2.5.4	Delete Device Access Codes.....28
2.5.5	Delete All Device Access Codes.....28
2.5.6	Temporary Device Access Code programming.....29
2.5.7	Delete Temporary Device Access Codes.....29
2.5.8	Delete All Temporary Device Access Codes.....29
2.6	Time Functions
2.6.1	Program the Calendar Chip.....30
2.6.2	Relay Hold Schedule.....31
2.6.3	Time Zones.....32
2.7	Miscellaneous
2.7.1	Restore Defaults.....33
2.7.2	Erase Transaction Log.....34

Section 3 – User Instructions

	LED Status Indicators.....	35
3.1	Remote Programming via Touch-tone Telephone	36
3.2	Remote Relay Activation via Touch-tone Telephone	36

Section 4 – Maintenance and Trouble Shooting

4.1	Trouble Shooting	37
4.2	Trouble Shooting Table	38
4.3	Internal Wire Diagram	39
4.4	Accessories	40
4.5	Programming Information Tables	41
	Access Code Log Sheets	42

Important Notices

FCC – United States

This equipment has been tested and found to comply with the limits for a class A digital device, pursuant to Part 15 of the FCC Rules and Regulations. These limits are designed to provide reasonable protection against harmful interference when the equipment is operated in a commercial environment. This equipment generates, uses, and can radiate radio frequency energy and, if not installed and used in accordance with the instruction manual, may cause harmful interference to radio communications. Operation of this equipment in a residential area is likely to cause harmful interference in which case the user will be required to correct the interference at his/her own expense.

FCC Registration Number: **DUF6VT-12874-OT-T**

DOC - Canada

The Canadian Department of Communications label identifies certified equipment. This certification means that the equipment meets certain telecommunications network protective, operational, and safety requirements. The Department does not guarantee the equipment will operate to the users satisfaction.

Before installing this equipment, users should ensure that it is permissible to be connected to the facilities of the local telecommunications company. The equipment must also be installed using an acceptable means of connection. The customer should be aware that compliance with the above conditions may not prevent degradation of service in some situations.

Repairs to certified equipment should be made by an authorized Canadian maintenance facility designated by the supplier. Any repairs or alterations made by the user to this equipment, or equipment malfunctions, may give the telecommunications company cause to request the user to disconnect the equipment.

Users should ensure, for their own protection, that the electrical ground connections of the power utility, telephone lines, and internal metallic water pipe system, if present, are connected together. This precaution may be particularly important in rural areas.

CAUTION: Users should not attempt to make such connections themselves, but should contact the appropriate electric inspection authority, or electrician, as appropriate.

DOC Registration Number: **1736 4507 A**

Notice:

The Load Number (LN) assigned to each terminal device denotes the percentage of the total load to be connected to a telephone loop which is used by the device, to prevent overloading. The termination on a loop may consist of any combination of devices subject only to the requirement that the sum of the load numbers of all the devices does not exceed 100.

Notice:

DoorKing does not provide a power transformer on units sold into Canada. Use only transformers that are CSA listed to power the access control system. The model 1838 Access Plus requires a 16-volt, 20 VA transformer.

General Information

- Prior to beginning the installation of the access control system, we suggest that you become familiar with the instructions, illustrations, and wiring guidelines in this manual. This will help insure that your installation is performed in an efficient and professional manner.
- The proper installation of the 1838 Access Plus is an extremely important and integral part of the overall access control system. Check all local building ordinances and building codes prior to installing this system. Be sure your installation is in compliance with local codes.
- **When used to control a vehicular gate with an automatic gate operator, the access device (card reader, keypad, etc.) must be mounted a minimum of ten (10) feet away from the gate and gate operator, or in such a way that a person cannot operate the entry system and/or touch the gate or gate operator at the same time.**
- Be sure that the access device is installed so that it is not directly in the traffic lane. Goose neck mounting post and kiosks work well for these type systems. When planning where to locate the system and access devices, take into consideration traffic lane layouts, turn around lanes for rejected access, conduit runs, power availability, etc.
- Environmental factors must also be taken into account. Surface mount access devices are designed for direct outdoor installations; however it is preferable to protect them from direct exposure to driven rain or snow whenever possible. Flush mount access devices must be protected from direct exposure to the elements.
- This access control system contains a number of static sensitive components that can be damaged or destroyed by static discharges during installation or use. Discharge any static prior to removing the circuit board from the lobby panel by touching a proper ground device.
- **Instruct the end user to read and follow these instructions. Instruct the end user to never let children play with or operate any access control device. This Owner's Manual is the property of the end user and must be left with them when installation is complete.**

Features

- The 1838 is an access controller that can control up to six (6) entry points via card, keypad or RF devices using RS-485 communication protocol. In addition, two (2) additional auxiliary relays are built into the system and are time zone controlled. These relays can be utilized to unlock or open a door or gate at preprogrammed times.
- IP Addressable – the 1838 Access Plus can be programmed from your PC using the DoorKing programming software via a LAN or WAN connection. It can also be programmed via the built-in modem (Central Office phone line required).
- 100 card / transmitter / keypad codes.
- Holiday schedule.
- 500 event transaction buffer.
- Built-in clock / calendar.
- Four hold-open time zones.
- Entry code time zones.
- 10 temporary access codes.

SECTION 1 - INSTALLATION

Installation of the 1838 Access Plus system involves the installation of the 1838 controller, access devices (card readers, keypads, etc.), and the wiring of these devices.



If used to control a vehicular gate with an automatic gate operator, the access devices (card readers, keypads, etc.) must be mounted a minimum of ten (10) feet away from the gate and gate operator, or in such a way that a person cannot operate the access device and/or touch the gate or gate operator at the same time.

1.1 Mount the 1838 Access Plus

The 1838 controller can be mounted directly to a wall. Be sure that the unit is securely mounted and is not subject to continuous vibration from closing doors or gates. Take into consideration the following items when considering where to mount the 1838 controller:

- Location of AC power
 - Location of network cable (maximum network cable run is 325 feet) and/or telephone line
 - RS-485 cable runs to access devices (maximum 4000 feet)
1. Open the cabinet of the 1838 and carefully disconnect the front panel terminal connector and the keypad connector. The front panel terminal connector is located in the lower right hand corner. The entire connector will come off the board by gently pulling it straight out.
 2. Remove four (4) 6-32 x 1/2 round head screws from each corner of the control board.
 3. Remove the control board from the housing. CAUTION: The control board contains static sensitive components. Discharge any static electricity from your hands by touching a proper ground device before removing the control board.
 4. Mount the 1838 housing assembly. Make any conduit connections at this time. Be sure that the mounting screws do not protrude into the cabinet where they could cause a short.
 5. Route wiring into the housing assembly at this time. DO NOT APPLY POWER.
 6. Clean out the control box. Be sure that all dirt, metal or wood debris is removed from the enclosure.
 7. Install the control board into the back box. Secure the control board with the four (4) 6-32 x 1/2 screws removed in step 2. CAUTION: The control board contains static sensitive components. Discharge any static electricity from your hands by touching a proper ground device before installing the control board.
 8. Plug the front panel connector onto the control board pins in the lower right hand corner. The red wire goes to the left.
 9. Plug the keypad connector onto the circuit board plug. The cable points down.

1.2 Dimensions

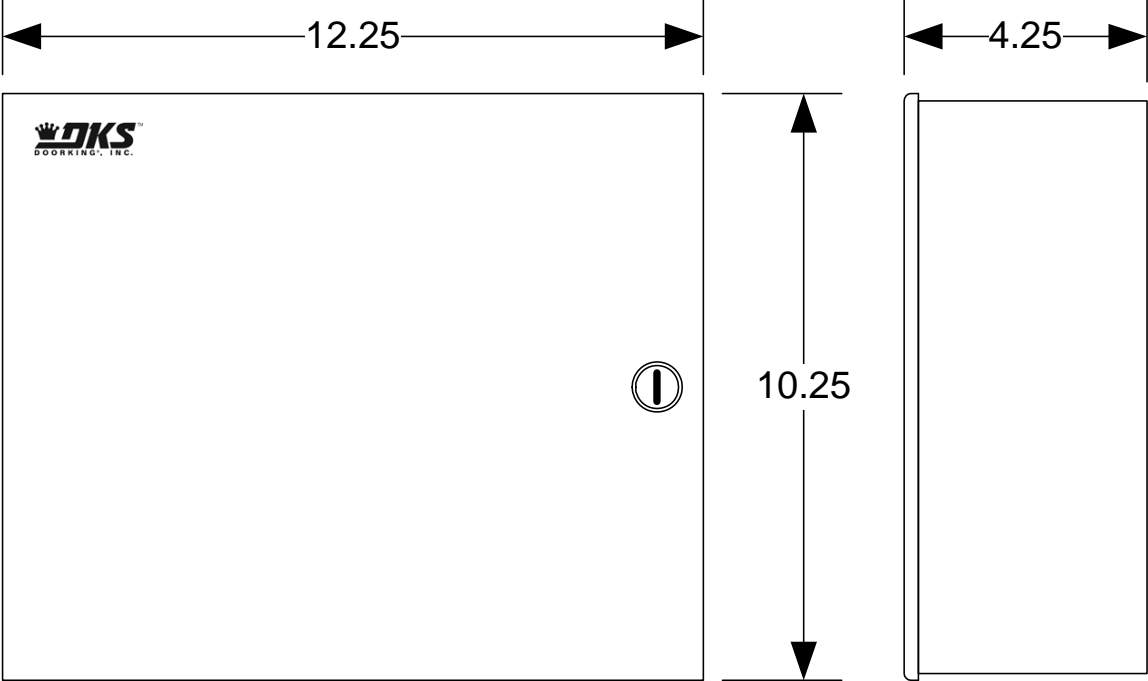

1838-095

1.3 Power Wiring

POWER WIRING	
WIRE SIZE	MAX DISTANCE IN FEET
18 AWG	100
16 AWG	200

The 1838 Access Plus operates on 16.5 VAC. Do not power this device with 24 volt AC power. Use the supplied power transformer, 16 VAC, 20 VA (or U.L. listed equivalent) to power the access controller. Do not power any other devices (electric strikes, magnetic locks, etc.) from this power transformer. For wire runs up to 100 feet, use 18 AWG wire. For wire runs up to 200 feet, use 16 AWG wire.

Do not run telephone lines or data cables and high voltage lines in the same conduit. Separate high voltage and telephone line / data cable conduits by at least six (6) inches.

1.4 Surge Suppression and Grounding

Proper grounding and the use of surge suppressers can significantly reduce the chance of component failure because of static charges or surges. To be effective, ground connections should be made with a minimum 12 AWG wire to a ground point within 10 feet of the device being protected. The ground point must be at an electrical panel, a metallic cold water pipe that runs in the earth, or a grounding rod driven at least 10 feet into the soil.

It is highly recommended that a low voltage surge suppresser (DoorKing p/n 1878-010) be installed to help protect the access controller from power surges.

It is highly recommended that telephone line surge suppresser (DoorKing p/n 1877-010) be installed to help protect the system from phone line power surges (if using a telephone line to program the 1838 via modem).

1.5 Telephone Line Wiring (optional)

This section is provided for information purposes if the 1838 Access Plus controller will be programmed via modem using a telephone line.

Be sure to observe electrical safety when working with phone lines. Phone lines carry electricity and the ring voltage can deliver a substantial jolt. The best policy is to disconnect the phone line from the phone company Network Interface Device (also known as 'Demarcation Device') before working on the wiring.

In older homes and buildings, the phone cable contains four wires; green, red, black, yellow. The green and red are twisted to make one pair and the black and yellow are twisted to make another pair (This allowed for the addition of a second phone line since telephones use only two wires). Most phone lines installed in the U.S. in the second half of the 20th Century have this type of wire. This type of wire is now obsolete. All new telephone projects are using Cat5 wire. If you have Cat5 wiring, the conversion is simple (see chart).

The convention for Cat5 wire is as follows:

- Colored pairs match; e.g., WHITE with blue mark goes with BLUE with white mark for one phone line, etc.
- The pairs are used in the order pictured: for the first line, you use BLUE, for the second line you use ORANGE, etc.
- An easy way to remember this is that the colors run from the sky to the earth. BLUE sky comes first; ORANGE sunset second; GREEN grass third; BROWN earth last.

Modern Wiring Cat5e or Cat6	Old Wiring Four Conductor
Tip 1 = WHITE / Blue Mark	Green
Ring 1 = BLUE / White Mark	Red
Tip 2 = WHITE / Orange Mark	Black
Ring 2 = ORANGE / White Mark	Yellow
Tip 3 = WHITE / Green Mark	
Ring 3 = GREEN / White Mark	
Tip 4 = WHITE / Brown Mark	
Ring 4 = BROWN / White Mark	

"Tip" and "Ring" are common terms in the telephone service industry referring to the two wires or sides of an ordinary telephone line. Tip is the ground side (positive) and Ring is the battery (negative) side of a phone circuit. The ground side is common with the central office of the telephone company (telco); the battery side carries -48 volts of DC voltage when in an "idle" or "on hook" state.

Phone Line Polarity. Tip and ring reversal is mostly immaterial, except for special circuits including DID (Direct Inward Dialing) trunks, T-1 lines, and ground start lines where the field side ("terminal") equipment (a company's PBX switch, for example) can only function correctly with correct tip and ring polarity.

1.6 Terminal Identification / Main Terminal Wiring

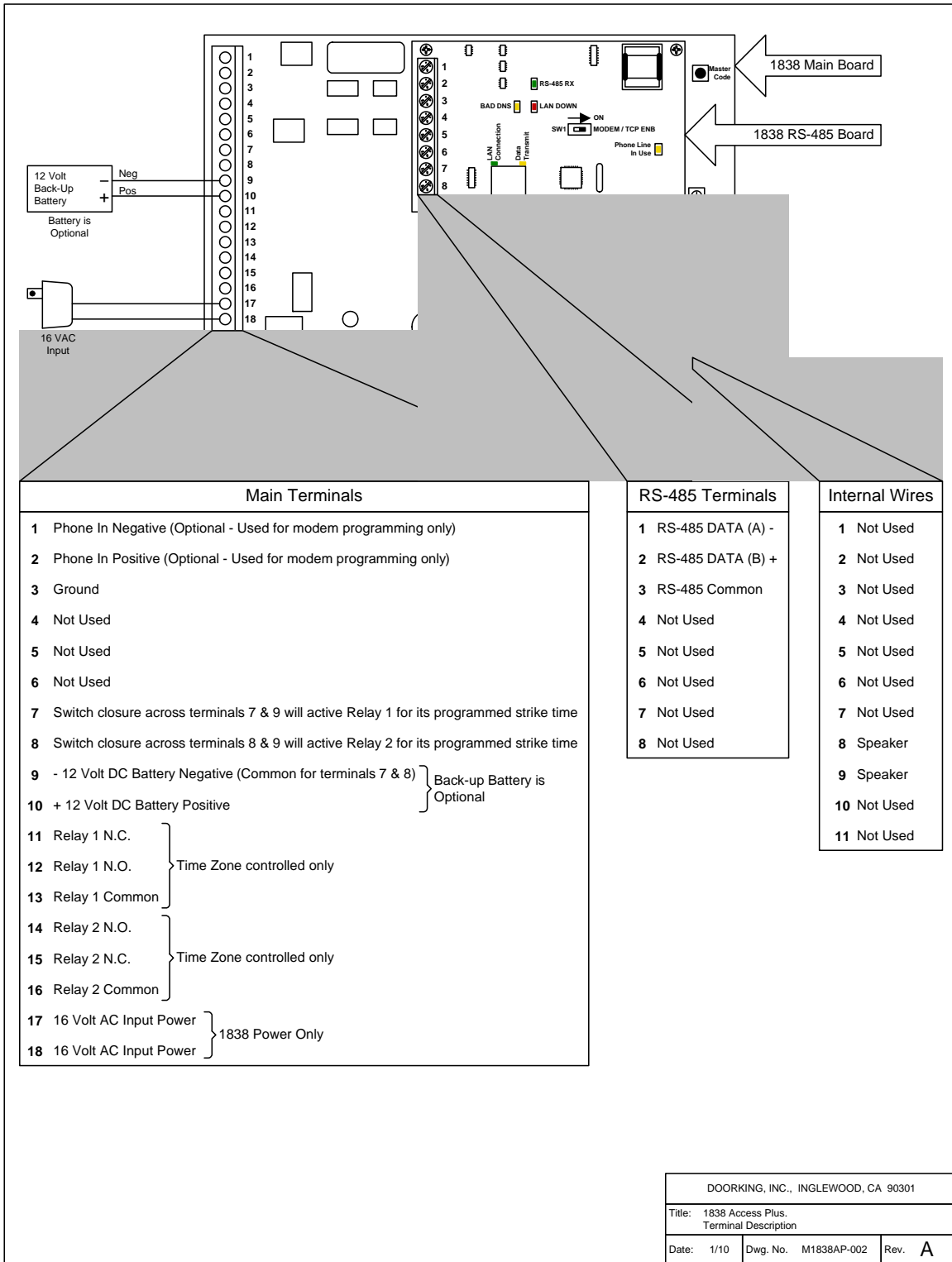

DOORKING, INC., INGLEWOOD, CA 90301		
Title: 1838 Access Plus. Terminal Description		
Date: 1/10	Dwg. No. M1838AP-002	Rev. A

1.7 RS-485 Wiring

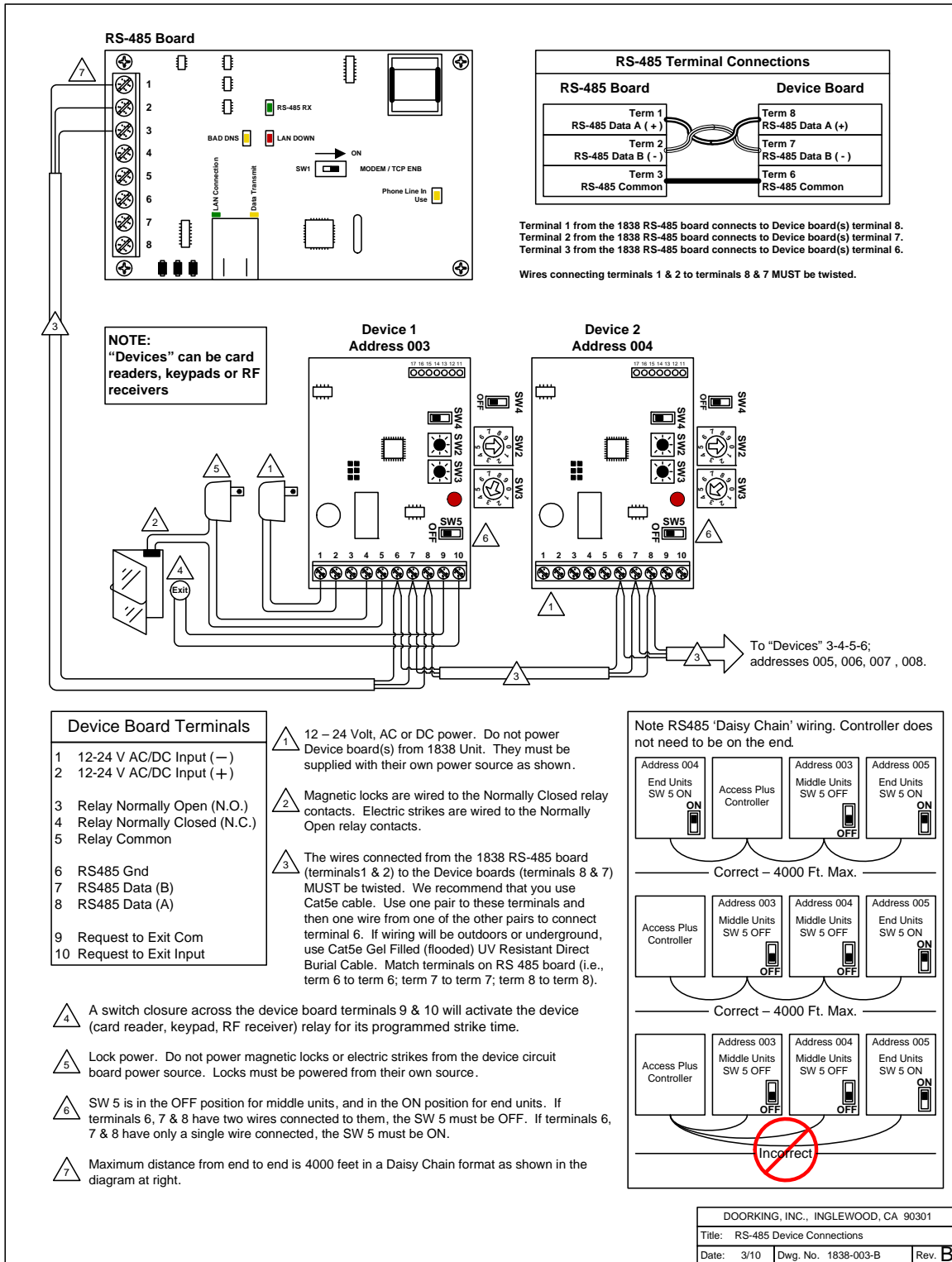

1.8 Network Connections

There are a number of ways to communicate with the 1838 Access Plus via a network connection. Before any programming can be attempted, you need to install the programming software on the computer you want to use for this purpose. The computer must have a network card installed. Follow the instructions in the programming software help guide and refer to section 2.3 for setup information.

Using a network connection, you can connect to the 1838 Access Plus in one of four different ways.

NOTE: Maximum distance on Cat5 wire runs is limited to 325 feet (100 meters).

- Locally with a direct connection from the computer to the 1838 Access Plus using a commercially available **crossover** cable.
- Locally by connecting the computer to the 1838 Access Plus through a router. This is a Local Area Network (LAN) connection.
- Through the internet with a static IP address. This is a Wide Area Network (WAN) connection and will require a router with an internet connection.
- Through the internet with a dynamic IP address. This is a Wide Area Network (WAN) connection and will require a router with an internet connection. You will also need a registered DDNS host name.

Direct Connection Using a Crossover Cable

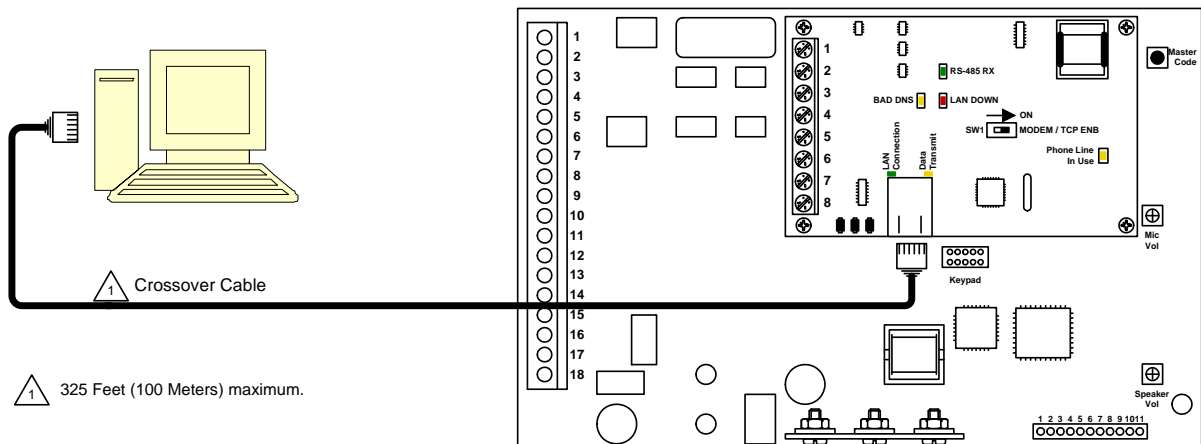

Direct Connection Using a Router (LAN)

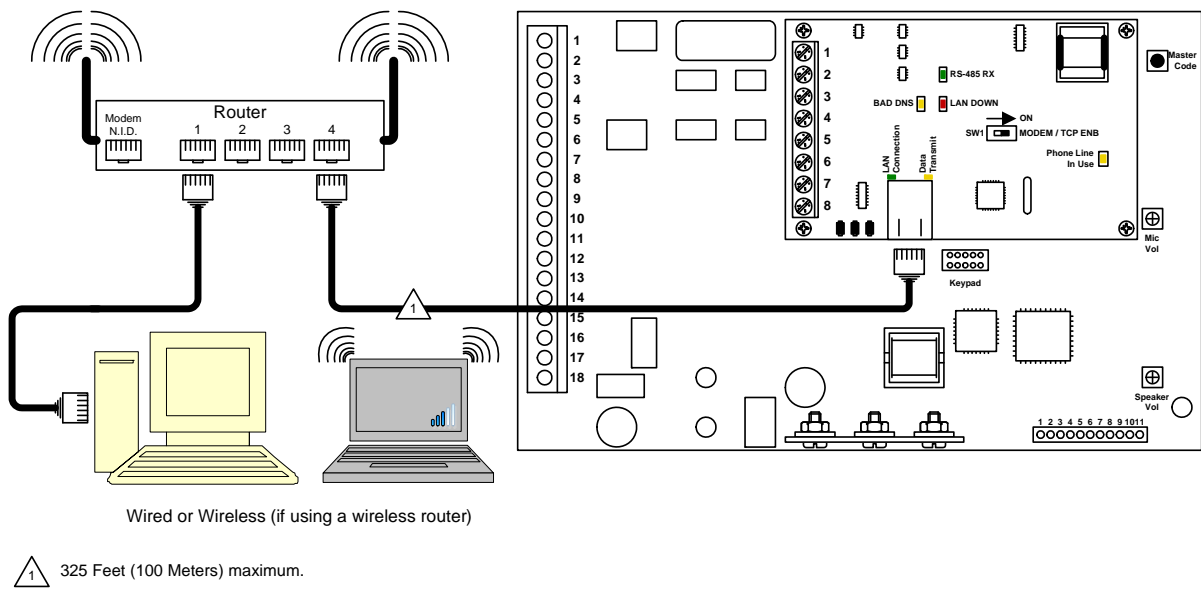

Through the Internet (WAN)

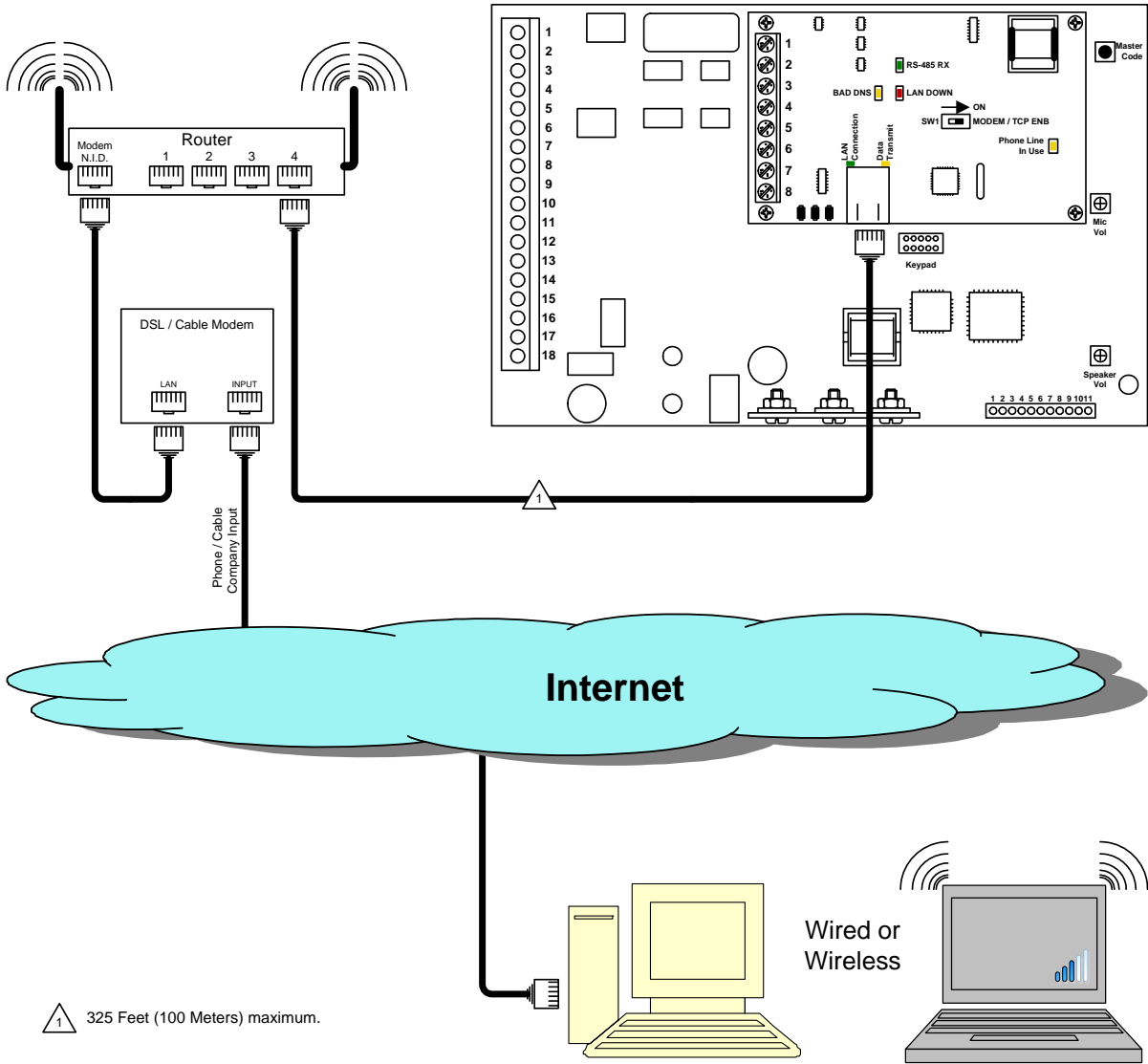

1.9 Modem Connections

The 1838 Access Plus has a built-in modem that can be used to connect to a PC. Before programming can be attempted, you need to install the programming software on the computer you want to use for this purpose. The computer must have modem installed or an external modem connected to it. Follow the instructions in the programming software help guide for setup information.

Modem Connection

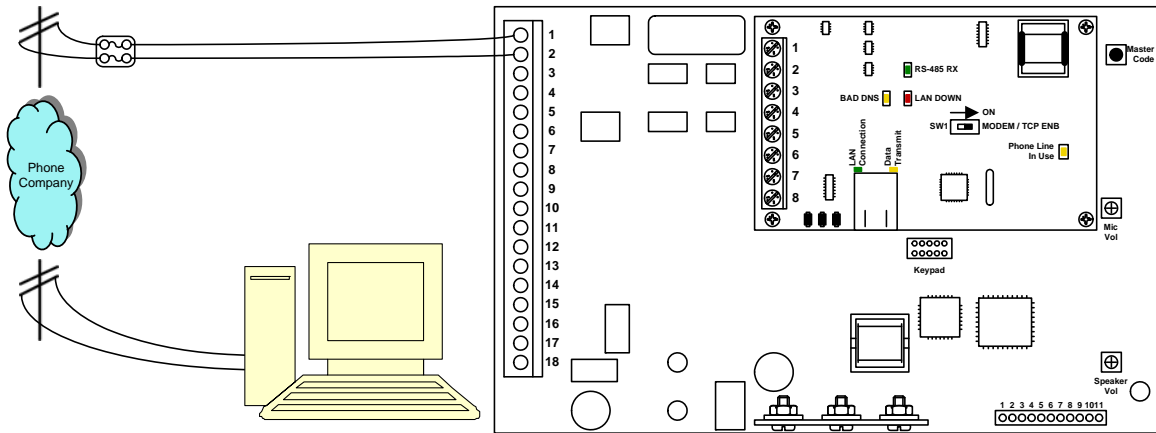

SECTION 2 – PROGRAMMING

Before You Start

IMPORTANT! We strongly suggest that you become familiar with these programming instructions before beginning any programming of the 1838 Access Plus system.

The 1838 has been programmed at the factory with many of the programming parameters already set (default setting). There is no need to reprogram these parameters unless you want to change them. For easy reference, refer to the chart on page 24 that list the various programming functions and their default settings.

2.1 Programming the Master Code

This programming step sets the system MASTER CODE. The master code is the four-digit number required to gain access to the system memory. **The master code can only be programmed from the system keypad.**

Default setting is NONE. You MUST program a Master Code.

1. Open the cabinet and press the master code button. The Blinking LED next to the button will turn ON.
Note: After you press the master code push button, the LED will turn ON indicating that you are in the master code programming sequence. If a master code is not entered within 10 seconds, the master code program sequence will automatically end and the LED will return to a blinking state indicating that you have exited the master code programming sequence.
2. Enter a four-digit master code then press *. [_ _ _ _ * (beep)] (The LED will revert to Blinking).
3. Close the cabinet.

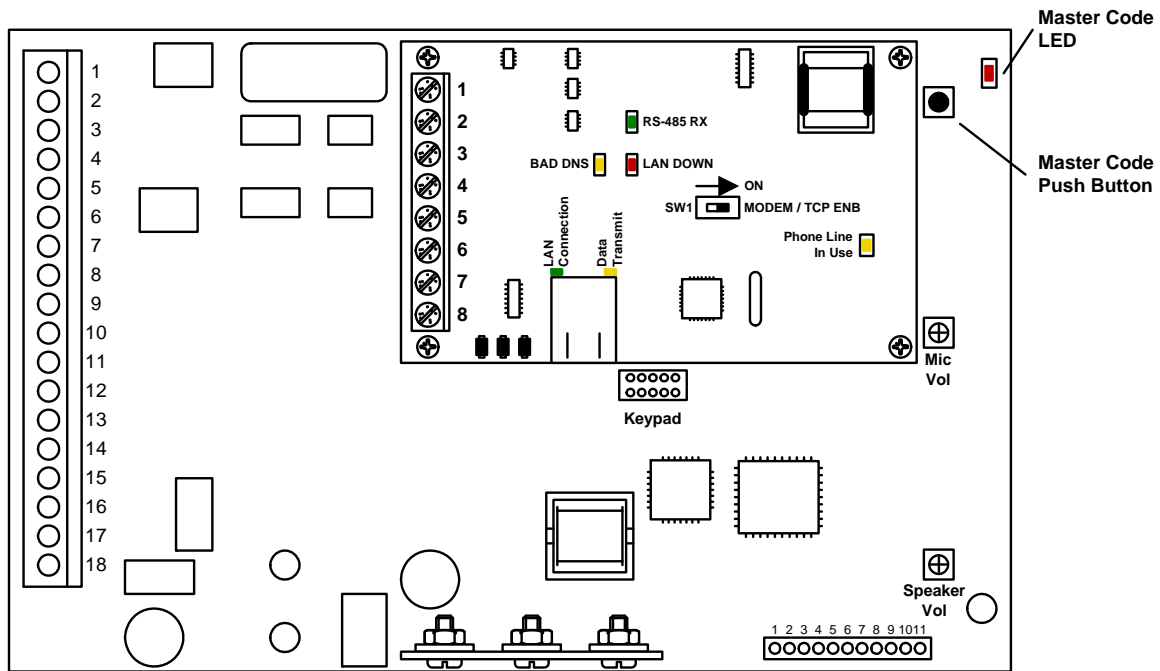

2.2 Programming Methods

The 1838 Access Plus can be programmed from a computer, the system keypad or from a touch-tone telephone connected to the system. We highly recommend programming the 1838 Access Plus from a computer using the DoorKing Management Software as this greatly simplifies the programming task. There are also several features in the 1838 Access Plus system that must be setup using a computer.

The following features and programming parameters can only be programmed from a computer.

Strike Out: This feature can be turned ON or OFF and will set the number of invalid access codes allowed before the system shuts down for a period of time. The default is OFF.

Holiday Schedules: Program up to 31 different Holiday schedules. This feature can be turned ON or OFF. The default is OFF.

Email Notification: Set the 1838 to send emails to a specified email address on events of your choice (Requires an Internet connection). This feature can be turned ON or OFF. The default is OFF.

Transaction Log: Download and view the system transaction log.

- **Computer (PC's only)**

This is the preferred method of programming the 1838 Access Plus as it will simplify all of the programming steps and allow you to enjoy all of the features and benefits available with this system. The 1838 Management software must be installed on your computer and the 1838 must be connected to the computer via one of the methods shown in section 1.8 or 1.9. Refer to the 1838 software help screens for more information.

- **Keypad**

We strongly recommend that you become familiar with the entire programming sequence before attempting to program some of the more complex features of this system using the system keypad. If you make a single error in the programming steps, you will have to re-do the sequence from the beginning.

- **Touch-Tone Telephone**

The programmable features that can be programmed using the system keypad can also be programmed using a touch-tone telephone connected to the 1838 through a Central Office phone line. This method of programming is useful for programming simple steps or for turning certain features ON or OFF, but is not recommended for complex programming steps.

2.3 Programming with a Computer (Network Setup)

Before proceeding with any of the programming steps in this section, install the 1838 Management software on the computer that will be used for this purpose. Be sure that the computer has a network card installed, or a modem installed in it (or connected to it) depending on which connection method will be used. Once the software is installed and the 1838 is connected, refer to the software programming steps and help screen instructions to proceed with the programming steps in this section.

Be sure that SW1 is in the ON position (MODEM/TCP ENB) on the interface board.

Reboot: If a programming step calls for a reboot, follow the programming steps in 2.3.1. If you are performing several programming steps that call for a reboot, complete all of those steps first, then perform the reboot sequence in 2.3.1.

2.3.1 Enable / Disable TCP / IP Support – System Reboot

Default value is: 0 (Disabled)

This programming sequence enables or disables the support for TCP / IP. It will also cause an automatic reboot of the 1838 two seconds after the programming sequence is completed. For this reason, **perform this step after all other network setup programming sequences have been completed (2.3.2 through 2.3.5) or whenever an individual network programming step is performed.**

1. Press * 5 0 and enter the MASTER CODE. [*** 5 0 _ _ _ _ (beep)**]
2. Press 0 * to disable OR press 1 * to enable. [**_ * (beep)**]
3. The system will reboot automatically.

Once the 1838 is connected, the green LED on the RJ-45 jack on the interface board should light indicating that a good wire connection has been made. The LAN DOWN LED should go off after a few seconds if all previous programming steps have been completed and programmed successfully.

2.3.2 Set the 1838 IP Address (reboot required)

Default value is: 192.168.001.030

This must be set to the same address that was programmed in the software. A valid value for any of the three digit numbers in this sequence is 000 to 255.

1. Press * 5 1 and enter the MASTER CODE. [*** 5 1 _ _ _ _ (beep)**]
2. Enter the IP address. Use the * key to enter the "dot."
[**_ _ _ * (beep) _ _ _ * (beep) _ _ _ * (beep) _ _ _ * (beep)**]
3. Press 0 # TOGETHER to end. [**0 # (beeeeeep)**]

2.3.3 Sub-Net Mask (reboot required)

Default value is: 255.255.255.000

All sub-net mask should be set to 255.255.255.000. If not, consult your network expert. Valid values for any of the three digit numbers is 000 to 255.

1. Press * 5 2 and enter the MASTER CODE. [*** 5 2** _____ (beep)]
2. Enter the sub-net mask number. Use the * key to enter the "dot."
[_____ * (beep) _____ * (beep) _____ * (beep) _____ * (beep)]
3. Press 0 # TOGETHER to end. [**0 #** (beeeeeep)]

2.3.4 Set the Gateway (router) IP Address (reboot required)

Default value is: 192.168.001.001

If the 1838 is connected directly to the computer with a crossover cable, then this address must be set to 000.000.000.000. If the 1838 is connected to the computer through a router, then set this value to the router's IP address. Valid value for any of the three digit numbers is 000 to 255.

1. Press * 5 3 and enter the MASTER CODE. [*** 5 3** _____ (beep)]
2. Enter the gateway (router) IP address. Use the * key to enter the "dot."
[_____ * (beep) _____ * (beep) _____ * (beep) _____ * (beep)]
3. Press 0 # TOGETHER to end. [**0 #** (beeeeeep)]

2.3.5 Set the Port Number (reboot required)

Default value is: 01030

This must be the same port number that was programmed in the software. Valid values are 01024 to 65535.

1. Press * 5 6 and enter the MASTER CODE. [*** 5 6** _____ (beep)]
2. Enter the port number, then press *. [_____ * (beep)]
3. Press 0 # TOGETHER to end. [**0 #** (beeeeeep)]

STOP!

If you are using a computer with the 1838 Access Plus, no other programming at the keypad is required. All programming parameters beyond this point can be set in the Management software.

2.4 System Parameters Programming

IMPORTANT! We strongly suggest that you read these programming instructions in their entirety before beginning any manual programming of the 1838 Access Plus system.

Programming from the Keypad

Follow the programming instructions as described in each section of this manual. The system will prompt you with short tones (beep) when programming steps have been followed correctly and with a long tone (beeeeeep) when the programming step is ended.

Programming with a Touch-Tone Telephone

NOTE: A telephone line must be connected to the 1838 to program the system via this method.

Follow these steps when programming the 1838 from an off-site location using a touch-tone telephone. NOTE: The 1838 must be programmed to answer incoming calls, section 2.4.3.

1. Call the telephone number of the phone line connected to the 1838. The 1838 will answer with a short beep after the programmed number of rings.
2. Follow the programming instructions as described in each section of this manual. The system will prompt you with short (beep) tones when programming steps have been followed correctly.
3. When complete, hang up.

System Parameters Programming Section 2.4			
Description	Command	Section	Default Value
Relay Strike Time	* 0 3	2.4.1	1 Sec
Tone Open Numbers	* 0 5	2.4.2	Relay 1: 9 8 7 6 Relay 2: 5 4 3 2
Answer Incoming Call on X Rings	* 1 8	2.4.3	6

Devices Section 2.5			
Description	Command	Section	Default Value
Program Number of RS-485 Devices	* 0 9	2.5.1	0
Program RS-485 Device Off-Line Function	* 0 7	2.5.2	0
Program Access Code	* 7 0	2.5.3	Empty
Delete Access Code	* 7 1	2.5.4	N / A
Delete All Access Codes	* 7 2	2.5.5	N / A
Program Temporary Access Codes	* 7 3	2.5.6	Empty
Delete Temporary Access Code	* 7 4	2.5.7	N / A
Delete All 10 Temporary Access Codes	* 7 5	2.5.8	N / A

Time Functions Section 2.6			
Description	Command	Section	Default Value
Program Calendar Chip	* 3 3	2.6.1	Empty
Program Relay Hold Schedule	* 3 5	2.6.2	Empty
Program Time Zones	* 3 6	2.6.3	Empty

Miscellaneous Section 2.7			
Description	Command	Section	Default Value
Restore Defaults	* 9 0	2.7.1	N / A
Erase Transaction Log	* 9 1	2.7.2	N / A

2.4.1 Relay Strike Time

Default setting for Relays 1 and 2 is 01 (1 Second). Relays 3 through 8 are not set.

These steps will program the system relay strike times. Strike times can be programmed from 1/4 second (enter 00 in step 3) up to 99 seconds.

System relays 1 and 2 are the two relays on the 1838 main circuit board. System relays 3 through 8 are the relays associated with additional RS-485 devices (card readers, keypads, RF receivers, etc.) connected to the system.

1. Press * 0 3 and enter the MASTER CODE. [*** 0 3 _ _ _ _ (beep)**]
2. Enter a relay number (1 – 8), then press *. [**_ * (beep)**]
3. Enter the two-digit strike time (00-99) then press *. [**_ _ * (beep)**]
4. Repeat steps 2 and 3 to set other relay strike times.
5. Press 0# TOGETHER to end. [**0# (beeeeeep)**]

2.4.2 Tone Open Numbers

Default setting is 9876 for relay 1; 5432 for relay 2. Relays 3 – 8 are not set.

NOTE: This programming sequence is applicable only if the 1838 will have a telephone line connected to it.

These steps will program the tone open number(s) for each relay in the system (each relay is programmed independently). You will need to enter a four-digit number (see chart below) to set each relay. If a function is not desired, enter # in place of a number. For example, if you want the relay to have a momentary activation function only, and you want the relay to activate when the number 9 is pressed, enter 9 # # # in step 3.

1. Press * 0 5 and enter the MASTER CODE. [*** 0 5 _ _ _ _ (beep)**]
2. Enter a relay number (1 – 8), then press *. [**_ * (beep)**]
3. Enter the four-digit tone open number code then press *. [**_ _ _ _ * (beep)**]
4. Repeat steps 2 and 3 to set other relay tone open numbers.
5. Press 0# TOGETHER to end. [**0# (beeeeeep)**]

4 Digit Tone Open Number Code	Function
1 st Digit	Momentary activation. The relay will activate for its programmed strike time.
2 nd Digit	Hold open. The relay will activate and remain activated until commanded to deactivate.
3 rd Digit	Deactivate relay.
4 th Digit	Hold open 1 hour. The relay will activate for 1 hour and then deactivate itself.

2.4.3 Answer Incoming Call on X Rings

Default setting is 06 (6 Rings).

NOTE: This programming sequence is applicable only if the 1838 will have a telephone line connected to it.

This programming section sets the number of rings that the 1838 will allow before it picks up the call. The number of rings to answer can be set from 1 to 12 rings and must be entered as a two-digit number. For example, if you want the 1838 to answer the call after the sixth ring, enter 06 in step 2. If you program 00 in step 2, this will prevent (disable) the 1838 from answering incoming calls to it.

1. Press * 1 8 and enter the MASTER CODE. [*** 1 8 _ _ _ _ (beep)**]
2. Enter the number of rings (01 – 99) then press *. [**_ _ * (beep)**]
(enter 00 in this step to disable this feature)
3. Press 0# TOGETHER to end. [**0# (beeeeeep)**]

2.5 Access Devices

2.5.1 Number of RS-485 Devices

Default value is 0.

This programming sequence sets how many remote RS-485 devices are connected to the 1838 Access Plus system.

1. Press * 0 9 and enter the MASTER CODE. [*** 0 9 _ _ _ _ (beep)**]
2. Enter the number of RS-485 devices connected, then press *. Valid numbers are 0 through 6. Entering a 0 in this step will disable RS-485 communication.
[**_ * (beep)**]
3. Press 0 # TOGETHER to end. [**0 # (beeeeeep)**]

2.5.2 Additional Relay Off-Line Function

Default value is 0.

This programming sequence sets how the remote RS-485 devices connected to the 1838 Access Plus will behave if RS-485 communication to the device fails.

Entering a 1 in step 2 sets the remote device to grant access to any five-digit card, transmitter or access code, whether it has been programmed into the system or not, if RS-485 communication fails. Entering a 0 in step 2 means that access will not be granted at the device if RS-485 communication fails. In this case, the 1838 Access Plus and any other remote devices may still be operating normally as long as they have a good RS 485 communication link.

1. Press * 0 7 and enter the MASTER CODE. [*** 0 7 _ _ _ _ (beep)**]
2. Enter a 0 or 1, then press *. [**_ * (beep)**]
3. Press 0 # TOGETHER to end. [**0 # (beeeeeep)**]

2.5.3 Device Access Code Programming

This programming sequence programs device (card readers, keypads, RF receivers, etc.) access codes into the system memory with time zone restrictions applied. It also allows programming of the device access codes to momentarily activate a relay or to hold (latch) a relay.

1. Press * 7 0 and enter the MASTER CODE. [*** 7 0 _ _ _ _ (beep)**]
2. Enter the device type (0=card, 1=transmitter, 2=keypad, 3=other), then press *. [**_ * (beep)**]
3. Enter the five-digit device access code then press *. [**_ _ _ _ _ * (beep)**]
4. Enter a minimum of 1, and a maximum of 4 time zones (valid time zones are 0 through 6) that you want to apply to this access code, then press *. [**_ _ _ _ * (beep)**]
Time zone 0 is always deny access, time zone 1 allows 24/7 access for relay 1 and any additional relays; time zone 2 allows 24/7 access for relay 2 and any additional relays. Time zones 3, 4, 5 and 6 are time zones that have been programmed in 2.6.3.
5. Enter 0 * for momentary relay activation or enter 1 * to hold (latch) the relay. [**_ * (beep)**]
6. Repeat steps 2 through 5 to program additional device access codes.
7. Press 0# TOGETHER to end. [**0# (beeeeeep)**]

2.5.4 Delete Device Access Codes

This programming sequence deletes device access codes that have been programmed into the system.

1. Press * 7 1 and enter the MASTER CODE. [*** 7 1 _ _ _ _ (beep)**]
2. Enter the device type (0=card, 1=transmitter, 2=keypad, 3=other), then press *. [**_ * (beep)**]
3. Enter the five-digit device access code to be deleted then press *. [**_ _ _ _ _ * (beep)**]
4. Repeat steps 2 and 3 to delete additional device access code numbers.
5. Press 0# TOGETHER to end. [**0# (beeeeeep)**]

2.5.5 Delete All Device Access Codes (of the same type)

This programming sequence deletes all device access codes for the same type of device.

WARNING: Once started, all devices of a type will be erased.

1. Press * 7 2 and enter the MASTER CODE. [*** 7 2 _ _ _ _ (beep)**]
2. Enter the device type (0=card, 1=transmitter, 2=keypad, 3=other), then press *. [**_ * (beep)**]
3. Press 9 9 9 9 then press *. [**9 9 9 9 * (beep)**]
4. The programming sequence will end itself automatically. [**beeeeeep**]

2.5.6 Temporary Device Access Code Programming

This programming sequence programs up to 10 temporary device access codes with a beginning and ending date and any time zone restrictions that may need to be applied.

1. Press * 7 3 and enter the MASTER CODE. [*** 7 3** _____ (beep)]
2. Enter the device type (0=card, 1=transmitter, 2=keypad, 3=other), then press *. [**_ *** (beep)]
3. Enter a five-digit device access code then press *. [_____ ***** (beep)]
4. Enter the beginning month (01-12) and day (01-31) then press *. [_____ ***** (beep)]
5. Enter the ending month (01-12) and day (01-31) then press *. [_____ ***** (beep)]
6. Enter a minimum of 1, and a maximum 4 time zones (valid time zones are 0 through 6) that you want to apply to this access code, then press *. [_____ ***** (beep)]
Time zone 0 is always deny access, time zone 1 allows 24/7 access for relay 1 and any additional relays; time zone 2 allows 24/7 access for relay 2 and any additional relays. Time zones 3, 4, 5 and 6 are time zones that have been programmed in 2.6.3.
7. Press 0 * for momentary relay activation **OR** press 1 * to hold (latch) the relay. [**_ *** (beep)]
8. Repeat steps 2 through 7 to program additional temporary device access codes.
9. Press 0# TOGETHER to end. [**0#** (beeeeeep)]

2.5.7 Delete Temporary Device Access Codes

This programming sequence deletes temporary device access codes that have been programmed into the system.

1. Press * 7 4 and enter the MASTER CODE. [*** 7 4** _____ (beep)]
2. Enter the device type (0=card, 1=transmitter, 2=keypad, 3=other), then press *. [**_ *** (beep)]
3. Enter a five-digit device access code then press *. [_____ ***** (beep)]
4. Repeat steps 2 and 3 to delete additional device access code numbers.
5. Press 0# TOGETHER to end. [**0#** (beeeeeep)]

2.5.8 Delete All Temporary Device Access Codes

This programming sequence deletes all (10) temporary device access codes that have been programmed into the system.

WARNING: Once started, all temporary access codes will be erased.

1. Press * 7 5 and enter the MASTER CODE. [*** 7 5** _____ (beep)]
2. Press 9 9 9 9 then press *. [**9 9 9 9 *** (beep)]
3. The programming sequence will end itself automatically. [**beeeeeep**]

2.6 Time Functions

2.6.1 Program Calendar Chip

This programming sequence programs the calendar chip in the 1838 system for the current time and date. The calendar chip must be programmed if any of the time related features are going to be used.

Note: The clock / calendar chip in the 1838 Access Plus will keep time for approximately 48 hours if power to the system is lost or removed. If power is off longer than this, the clock / calendar chip will have to be reprogrammed.

1. Press * 3 3 and enter the MASTER CODE. [*** 3 3 _ _ _ _ (beep)**]
2. Enter the current hour (01-12) and minutes (01-59) then press *. [**_ _ _ _ * (beep)**]
3. Press 0 * for AM, **OR** press 1 * for PM. [**_ * (beep)**]
4. Enter the month (01-12) day of the month (01-31) and the year (00-99) then press *. [**_ _ _ _ _ * (beep)**]
5. Enter the day of the week (1-7) then press *. [**_ * (beep)**]
Sun = 1, Mon = 2, Tue = 3, Wed = 4, Thu = 5, Fri = 6, Sat = 7.
6. Press 0# TOGETHER to end. [**0# (beeeeeep)**]

EXAMPLE: Saturday, February 14th, 2009, 11:30 AM.

1. * 3 3 _ _ _ _ (beep)
2. 1 1 3 0 * (beep)
3. 0 * (beep)
4. 0 2 1 4 0 9 * (beep)
5. 7 * (beep)
6. 0 # (beeeeeep)

2.6.2 Relay Hold Schedule

Default setting in step 3 is 0 (Hold schedules are OFF).

This program sequence sets up schedules to automatically activate and deactivate relays 1 through 8. Four schedules can be programmed, each of which can be assigned to the desired relay(s). These schedules can be independently turned on or off after they have been programmed.

1. Press * 3 5 and enter the MASTER CODE. [*** 3 5 _ _ _ _ (beep)**]
2. Enter a schedule number (1, 2, 3 or 4) then press *. [**_ * (beep)**]
3. Press 0 * to turn the schedule off, **OR** press 1 * to turn the schedule on. [**_ * (beep)**]
You can terminate here (step 11) if you have previously programmed the schedules and only ON / OFF is desired.
4. Enter the begin time hour (01-12) and minutes (01-59) then press *. [**_ _ _ _ * (beep)**]
5. Press 0 * for AM, **OR** press 1 * for PM. [**_ * (beep)**]
6. Enter the end time hour (01-12) and minutes (01-59) then press *. [**_ _ _ _ * (beep)**]
7. Press 0 * for AM, **OR** press 1 * for PM. [**_ * (beep)**]
8. Enter the days of the week that the hold open schedule is to be active then press *. [**_ _ _ _ _ _ * (beep)**]
Sun = 1, Mon = 2, Tue = 3, Wed = 4, Thu = 5, Fri = 6, Sat = 7.
You can enter up to 7 numbers here (1-7). For example, for the hold open schedule to be active only on Saturdays and Sundays, enter 1 7. The order of the numbers is not important; 17 is the same as 71.
9. Enter the relay number(s) that the schedule will apply to, then press *. [**_ * (beep)**]
You can enter a single relay number here; all relay numbers, or any combination of relay numbers.
10. Repeat steps 2 through 9 to program the other time zones.
11. Press 0# TOGETHER to end. [**0# (beeeeeep)**]

2.6.3 Time Zones

Default setting in step 3 is 0 (Time Zones are OFF).

This programming sequence sets up time zones (up to 4) that can be applied to the device access codes programmed into the 1838. These time zones can be turned on or off once they have been programmed.

1. Press * 3 6 and enter the MASTER CODE. [*** 3 6 _ _ _ _ (beep)**]
2. Enter a time zone number (3, 4, 5 or 6) then press *. [**_ * (beep)**]
Do not use 0, 1 or 2 for time zone numbers. These are already used; 0 = always deny, 1 = 24/7 access for relay 1, and relays 3-8; 2 = 24/7 access for relay 2, and relays 3-8.
3. Press 0 * to turn time zone off, **OR** press 1 * to turn time zone on. [**_ * (beep)**]
You can terminate here (step 11) if you have previously programmed the time zone schedule and only ON / OFF is desired.
4. Enter the begin time hour (01-12) and minutes (01-59) then press *. [**_ _ _ _ * (beep)**]
5. Press 0 * for AM, **OR** press 1 * for PM. [**_ * (beep)**]
6. Enter the end time hour (01-12) and minutes (01-59) then press *. [**_ _ _ _ * (beep)**]
7. Press 0 * for AM, **OR** press 1 * for PM. [**_ * (beep)**]
8. Enter the days of the week that the time zone is to be active then press *. [**_ _ _ _ _ _ * (beep)**]
*Sun = 1, Mon = 2, Tue = 3, Wed = 4, Thu = 5, Fri = 6, Sat = 7.
You can enter up to 8 numbers here (1-7). For example, for the time zone to be active only on Saturdays and Sundays, enter 1 7. The order of the numbers is not important; 17 is the same as 71.*
9. Enter the relay number(s) that the time zone will apply to, then press *. [**_ * (beep)**]
You can enter a single relay number here; all relay numbers, or any combination of relay numbers.
10. Repeat steps 2 through 9 to program the other time zones.
11. Press 0# TOGETHER to end. [**0# (beeeeeep)**]

2.7 Miscellaneous

2.7.1 Restore Defaults

This step will restore the factory set defaults for each of the programming parameters.

WARNING: Once started, this sequence will program all values to factory default.

1. Press * 9 0 and enter the MASTER CODE. [* 9 0 _ _ _ _ (beep)]
2. Press 9 9 9 9 then press *. [9 9 9 9 * (beep)]
3. This sequence will end itself automatically. [beeeeeep]

2.7.2 Erase Transaction Log

This step will erase (empty) the transactions stored in the system history buffer (the system stores up to 500 transactions).

WARNING: Transaction log cannot be recovered after this sequence is started.

1. Press * 9 1 and enter the MASTER CODE. [* 9 1 _ _ _ _ (beep)]
2. Press 9 9 9 9 then press *. [9 9 9 9 * (beep)]
3. This sequence will end itself automatically in about 3 seconds. [beeeeeep]

SECTION 3 – USR INSTRUCTIONS

LED Status Indicators

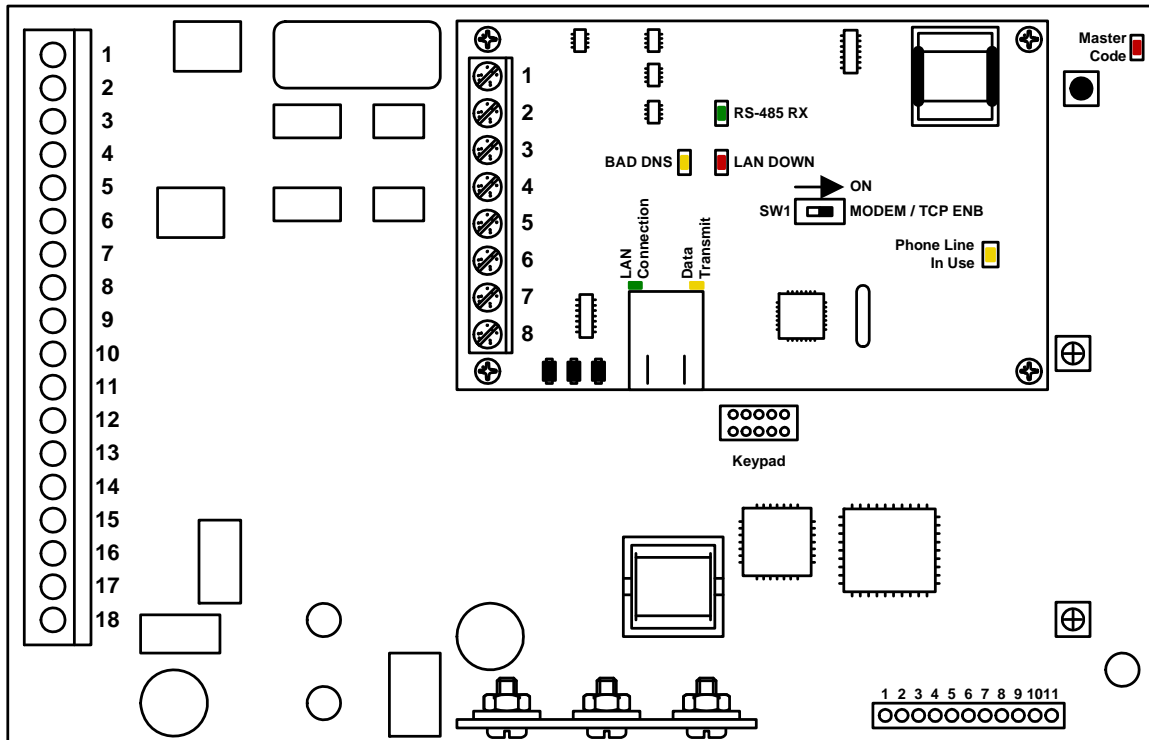

Master Code

Blink

RS-485 RX

Green LED indicates that the system is on-line and scanning the RS-485 devices.

BAD DNS

Yellow LED indicates an email server problem, rejecting the mail server.

LAN DOWN

Red LED indicates a problem with the LAN. IP or Gateway (router) down or wrong gateway IP address.

Phone Line In Use

Yellow LED indicates that the phone line is being used (dial-out, call forwarding, etc.)

LAN Connection

Green LED indicates that the wire connection from the 1812 to the computer or router is good.

DATA Transmit

Yellow LED indicates that the TCP / IP connection is transmitting data or sending an email.

SW1 - Modem TCP Enable

This switch should be in the ON position. Turning SW1 Off will reset the TCP/IP connection and should be used for troubleshooting purposes only.

3.1 Remote Programming via touch-tone telephone

NOTE: Applicable only if a telephone line is connected to the 1838.

The 1838 can be programmed and operated from a remote location using a touch-tone telephone. Be sure that the ability for the 1838 to answer an incoming call has not been disabled (see 2.4.3).

Note: The 1838 master code cannot be programmed remotely – it can only be programmed from the system keypad – see Programming the Master Code on page 19.

1. Call the 1838 phone number. After the programmed number of rings (2.4.3) the 1812 will answer with a tone.
2. Follow the desired programming steps in Section 2.4, 2.5, 2.6 and 2.7 of this manual.
3. When complete with the desired programming function, hang up. You cannot use 0# to end programming steps from a touch-tone telephone.

3.2 Remote Relay Activation via touch-tone telephone

NOTE: Applicable only if a telephone line is connected to the 1838.

The 1838 system relays can be activated from a remote (off site) location. Be sure that the ability for the 1838 to answer an incoming call has not been disabled (see 2.4.3). Refer to the tone open numbers that were programmed in section 2.4.2 to determine each of the activation numbers.

- **Momentary Activation** (Relay activates for its programmed strike time)
- **Hold Open** (Relay will activate and remain activated).
- **Deactivate** (Relay will deactivate)
- **Hold 1 Hour** (Relay will activate for 1 hour and then automatically deactivate)

To activate the relay(s) from a remote (off-site) location, perform the following steps.

1. Call the 1838 phone number. After the programmed number of rings (2.4.3) the 1812 will answer with a tone.
2. Press * 1 6 and enter the MASTER CODE. [* 1 6 _ _ _ _ (beep)]
(Two-way voice communication is also enabled at this point)
3. Enter the desired tone open number. [_ (beep)]
4. Hang up.

SECTION 4 – MAINTENANCE

The DoorKing 1838 access controller is essentially a maintenance free device. When the unit is properly installed, it should provide years of trouble free service. Maintenance is limited to updating the access codes and temporary access codes on an as needed basis.

4.1 Troubleshooting

If problems should develop with your access control system, refer to the trouble-shooting guide on the following pages to try and correct any problems. Our experience has shown that a majority of reported problems are actually programming related and can be corrected on site. If problems persist and they cannot be corrected, contact your authorized DoorKing dealer for assistance. Before performing any troubleshooting, check the following:

1. Have a good VOM meter handy to check voltages and continuity.
2. Have a telephone test set (DoorKing p/n 1800-050 or equivalent) to check the telephone line (if using the modem for programming). Noise on the phone line will cause problems with programming the access controller.
3. Check the polarity of the phone lines (if using the modem for programming). See section 5.2.
4. Be sure that the 1838 housing is properly grounded.
5. Be sure that the telephone wires are twisted (if using the modem for programming).
6. A hum on the system (if using the modem for programming) indicates that the phone line or 16 VAC power lines may be grounded. Check to be sure that the phone lines or power lines are not shorted to ground. Be sure that the cable used for communication is a twisted pair, good quality phone cable insulated for direct underground burial. Using phone wire that is designed for indoor use only can absorb moisture and cause a hum on your phone line.
7. Check the 16 VAC system power. Be sure that the transformer is properly rated (20 VA). Keep the wire run from the transformer to the entry system as short as possible. Use 16 or 18 AWG, 600 volt insulated wire only. **The importance of proper power wiring cannot be over stressed!**

4.2 Troubleshooting Table

SYMPTOM	POSSIBLE SOLUTION(S)
Cannot get into programming mode.	<ul style="list-style-type: none"> • Wrong master code entered. Start over. • Waiting too long between pushing buttons. Enter information quicker. • Keypad is not plugged into board correctly. Cable points down.
System emits a long tone and cancels programming.	<ul style="list-style-type: none"> • Waiting too long between pushing buttons. • Forgetting to press * first when programming.
Keypad is dead.	<ul style="list-style-type: none"> • No power. Check for 16 VAC input power. • Check that the keypad is properly connected to the circuit board. The cable on the plug points down when connected to the circuit board.
Buzz or noise on the line.	<ul style="list-style-type: none"> • Check for 16-volt power shorted to a conduit. • Check for a phone line shorted to ground. • Check that the phone wires are twisted. • Check that the cabinet is properly grounded. Be sure case ground (terminal 3) is not used as a low voltage common. • Check for excessive voltage drop on 16 VAC power. • Check phone line with telephone test set.
System will not answer when called from a remote location.	<ul style="list-style-type: none"> • Answer incoming call feature is turned off. Turn answer incoming call feature on. • Number of rings to answer may be programmed too high. Reprogram number of rings to answer.
Electric strike locks on or gate operator holds open.	<ul style="list-style-type: none"> • Excessive voltage drop on 16 VAC line. • Hold open schedule is enabled. Turn off hold open schedule or reprogram time zone. • Access code used was programmed under a hold location code. Reprogram access code into a momentary activation location code. • A hold command was sent to the relay from the resident's phone. Deactivate the relay using the resident's phone.
Access code will not work.	<ul style="list-style-type: none"> • Forgetting to press # first. • Access code is time zone restricted and the access code time zone is enabled. Turn access code time zone off, reprogram time zone boundaries or reprogram access code without a time zone.

4.3 Internal Wire Diagram

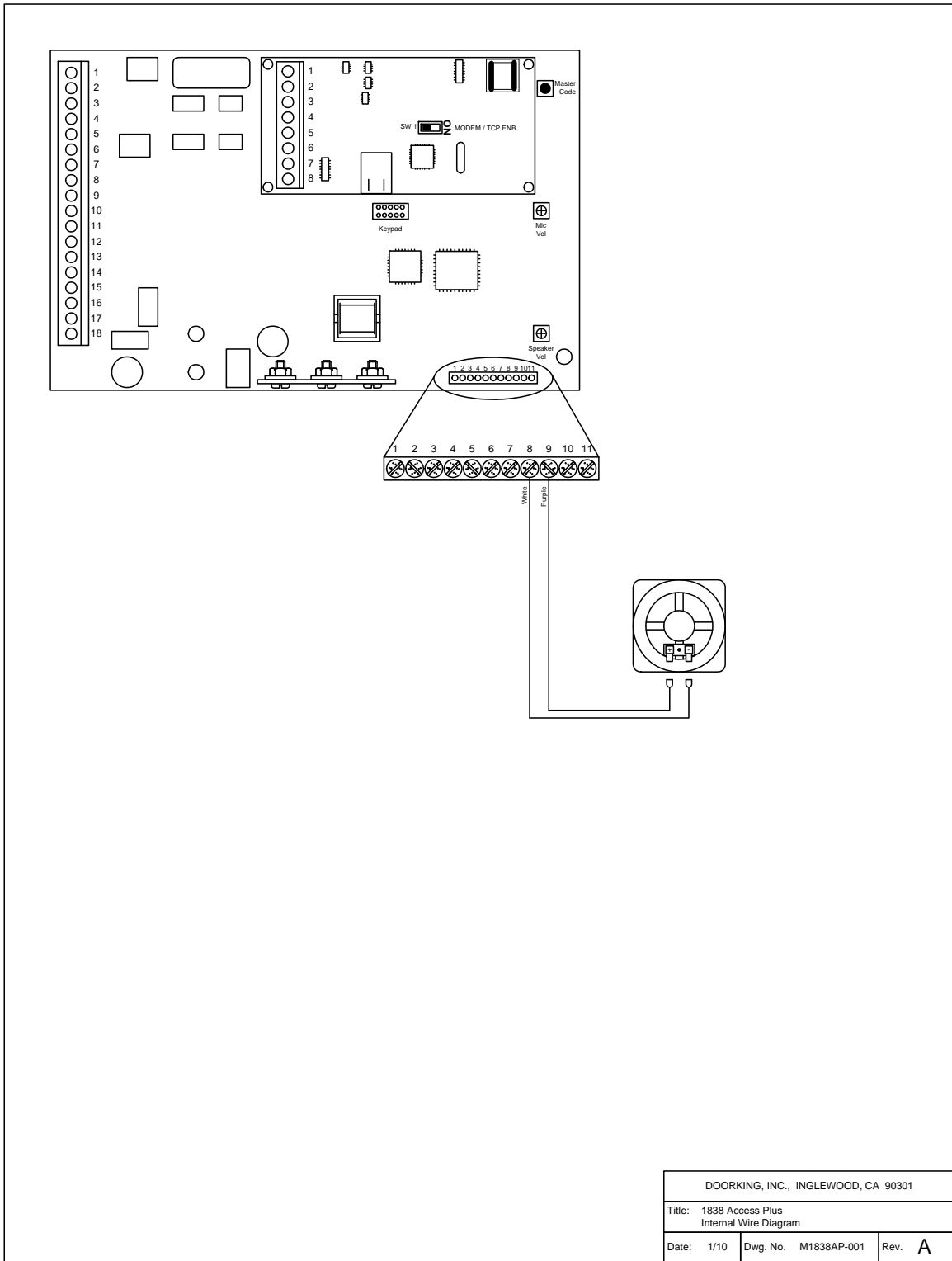

4.4 Accessories

RS-485 Card Reader	P/N 1815-232
RS-485 Keypad	P/N 1513-080
RS-485 Receiver	P/N 8053-080
Secondary Keypad	Allows remote activation of the system relays by use of the access codes. Does not provide any voice communication to the main unit or to the resident telephone. P/N 1812-082.
Surge Suppressers	High voltage (115 V) suppresser. P/N 1876-010. Phone line suppresser. P/N 1877-010. Low voltage (28 V) suppresser. P/N 1878-010.
Mounting Post	Gooseneck mounting post with concrete base plate. P/N 1200-045. Gooseneck mounting post – direct burial. P/N 1200-046.
Telephone Test Set	Includes clips, cord and carrying case. P/N 1800-050.
Battery	12 volt .8 amp hour gel cell provides stand by power during power interruptions. P/N 1801-008.
Postal Lock Box	Provides a means for the mail carrier to enter the premise to deliver mail. P/N 1402-080.
Magnetic Locks	A variety of magnetic locks are available to meet individual application requirements. Contact your DoorKing dealer.
Electric Strikes	A variety of electric strikes are available to meet individual application requirements. Contact your DoorKing dealer.

4.5 Tables

Complete the information in the tables on the following pages to maintain a record of the information that has been programmed into the 1838 access control system.

MASTER CODE			

Tone Number Function	Relay							
	1	2	3	4	5	6	7	8
Momentary								
Hold								
Release								
Hold 1 Hr.								

Access Code Time Zone Schedules				
	Zone 1	Zone 2	Zone 3	Zone 4
Begin Time				
End Time				
Days of Week				
Relays				

Hold Open Schedules				
	Schedule 1	Schedule 2	Schedule 3	Schedule 4
Begin Time				
End Time				
Days of Week				
Relays				

