



Owner's Manual

1820

Telephone Intercom System with Call Down

DoorKing, Inc.
120 Glasgow Avenue
Inglewood, California 90301
U.S.A.
Phone: 310-645-0023
Fax: 310-641-1586
www.doorking.com

Use this manual with the following models only.

Model 1820 Telephone Intercom Systems with circuit board 1885-010, Rev A or higher.

DoorKing, Inc. reserves the right to make changes in the products described in this manual without notice and without obligation of DoorKing, Inc. to notify any persons of any such revisions or changes. Additionally, DoorKing, Inc. makes no representations or warranties with respect to this manual. This manual is copyrighted, all rights reserved. No portion of this manual may be copied, reproduced, translated, or reduced to any electronic medium without prior written consent from DoorKing, Inc.

Table of Contents

Preface

FCC (US) Notices	6
DOC (Canada) Notices	7
General Information	8

Section 1 – Installation

1.1	General Information	9
1.1.1	Main and Auxiliary Cabinet Information	10
1.1.2	Garden Style Cabinet Information	11
1.2	RJ71C Phone Block Installation	12
1.3	Cabinet, Relay and Component Identification	14
1.3.1	Main Control Cabinet	14
1.3.2	Auxiliary Cabinets	14
1.3.3	Line Interface Boards	16
1.3.4	Power Supply Boards	16

Section 2 – Wiring

	General Information	19
2.1	Main Garden Style Cabinet	20
2.2	Main Cabinet	21
2.2.1	Auxiliary Cabinets	22
2.3	Powered RJ71C Wiring	23
2.3.1	Dual Line Interface Board Option	23
2.3.2	Dual RJ71C Option	23
2.4	Circuit Board Connector Locations	26
2.5	Main Circuit Board Terminal Description	27

Section 3 – Programming

3.1	System Set Up	29
3.1.1	Master Code	29
3.1.2	1882 Relay Board / 1884 Interface Board Selection	29
3.1.3	Last Available Relay	30
3.1.4	Setting the System Time Clock	31
3.1.5	Set the Caller ID Number	31
3.1.6	Set the Talk Time	31
3.1.7	Number of Rings / Ring Type	32
3.1.8	Tone Open Number Programming	32
3.1.9	Relay Strike Time	32
3.2	Directory Codes	33
3.2.1	Programming Directory Codes	33
3.2.2	Turning Programmable Directory Codes On / Off	34
3.2.3	Directory Code for Doorman / Concierge Phone	34
3.2.4	Erasing All Programmed Directory Codes	34
3.3	Dedicated Phone Line Access	35
3.3.1	Doorman / Concierge Outside Line Access	35
3.3.2	Preprogrammed Phone Numbers	35
3.3.3	Erase Preprogrammed Phone Number	36
3.3.4	Erase All Preprogrammed Phone Numbers	36
3.4	Entry Codes	37
3.4.1	Programming Entry Codes	37
3.4.2	Erasing Individual Entry Codes	37
3.4.3	Erasing All Entry Codes	37

3.5	Do Not Disturb Feature / Commands	
3.5.1	Do Not Disturb Feature On / Off System Wide	38
3.5.2	Set 1-Time Do Not Disturb Timer for Residents.....	38
3.5.3	Schedule Do Not Disturb On / Off	39
3.5.4	Setting Do Not Disturb Schedule	39
3.6	Call Forwarding Features / Commands	
3.6.1	Set Up Call Forwarding System Wide.....	40
3.6.2	Call Forwarding On / Off per Resident	40
3.6.3	Program Call Forward Numbers	41
3.6.4	Delete Call Forward Numbers.....	41
3.6.5	Program Call Forward Allowed Area Codes	42
3.6.6	Delete Call Forward Allowed Area Codes	42
3.6.7	Delete All Call Forward Allowed Area Codes.....	42
3.7	Virtual Doorman	
3.7.1	Virtual Doorman On / Off System Wide	43
3.7.2	Set Virtual Doorman Relay Strike Time	43
3.7.3	Virtual Doorman On / Off per Resident	43
3.8	Call-Down Features / Commands	
3.8.1	Call-Down Feature On / Off System Wide	44
3.8.2	Set Doorman to Enable / Disable Direct Connect.....	44
3.8.3	Set Direct Connect Disable Timer.....	45
3.8.4	Set Direct Connect Call-Down Number.....	45
3.8.5	Set Resident Programming Number	45

Section 4 – Operating Instructions

4.1	Administrator and Doorman Commands	
4.1.1	Lobby Panel On / Off.....	47
4.1.2	Calling the Lobby Panel	47
4.1.3	Accessing the Outside Phone Line	47
4.1.4	Calling a Preprogrammed Phone Number.....	47
4.1.5	Calling the Doorman or Lobby Panel from an Off Site Location	48
4.1.6	Lobby Panel Relay Activation	48
4.1.7	Calling a Resident without C.O. Phone Service From an Off Site Location.....	48
4.1.8	Turn Direct Connect On / Off	49
4.1.9	Call Back a Resident.....	49
4.1.10	Clear Call Back Number Queue.....	49
4.2	Technician Commands	
4.2.1	Reset Main Control Board.....	50
4.2.2	Reset Main Control Board Resident Programming.....	51
4.2.3	Set Touch-Tone Detect Time	52
4.2.4	Reset Line Interface Board Programming.....	52
4.2.5	Send Software Reset to all Line Interface Boards	52

Appendix

Programming Table	53
Resident Log Sheet	54
RJ71C Phone Block Identification Sheet for Garden Style Main Cabinet	55
RJ71C Phone Block Identification Sheet for Garden Style Auxiliary Cabinet.....	56
RJ71C Phone Block Identification Sheet for Main Cabinet	57
RJ71C Phone Block Identification Sheet for Auxiliary Cabinet.....	58
Resident Instruction Sheet.....	59
Resident Advanced Feature Programming Instructions	60

FCC - UNITED STATES

This equipment complies with Part 68 of the FCC rules and the requirements adopted by the ACTA. On the **BOTTOM** of this equipment is a label that contains, among other information, a product identifier in the format US: AAAEQ##TXXXX. If requested, this number must be provided to the telephone company.

This equipment uses the following Universal Service Order Codes ("USOC") jacks: **RJ11**.

A plug and jack used to connect this equipment to the premises wiring and telephone network must comply with the applicable FCC Part 68 rules and requirements adopted by the ACTA. A compliant telephone cord and modular plug is provided with this product. It is designed to be connected to a compatible modular jack that is also compliant. See installation instructions for details.

The REN is used to determine the number of devices that may be connected to a telephone line. Excessive RENs on a telephone line may result in the devices not ringing in response to an incoming call. In most but not all areas, the sum of RENs should not exceed five (5.0). To be certain of the number of devices that may be connected to a line, as determined by the total RENs, contact the local telephone company. For products approved after July 23, 2001, the REN for this product is part of the product identifier that has the format US: AAAEQ##TXXXX. The digits represented by ## are the REN without a decimal point (e.g., 03 is a REN of 0.3).

If this equipment Telecom Intercom System causes harm to the telephone network, the telephone company will notify you in advance that temporary discontinuance of service may be required. But if advance notice isn't practical, the telephone company will notify the customer as soon as possible. Also, you will be advised of your right to file a complaint with the FCC if you believe it is necessary.

The telephone company may make changes in its facilities, equipment, operations or procedures that could affect the operation of the equipment. If this happens, the telephone company will provide advance notice in order for you to make necessary modifications to maintain uninterrupted service.

If trouble is experienced with this Telecom Intercom System, for repair or warranty information, please contact **DoorKing, Inc. at 310-645-0023**. If the equipment is causing harm to the telephone network, the telephone company may request that you disconnect the equipment until the problem is resolved.

There are no user serviceable parts in this equipment.

Connection to party line service is subject to state tariffs. Contact the state public utility commission, public service commission or corporation commission for information.

If your home has specially wired alarm equipment connected to the telephone line, ensure the installation of this Telecom Intercom System does not disable your alarm equipment. If you have questions about what will disable alarm equipment, consult your telephone company or a qualified installer.

Electrical Safety Advisory:

Parties responsible for equipment requiring AC power should consider including an advisory notice in their customer information suggesting the customer use a surge arrestor.

FCC Registration Number: DUF6VT-12874-OT-T

DOC – CANADA CUSTOMER INFORMATION

This product meets the applicable Industry Canada Technical Specifications. This is confirmed by the registration number. The abbreviation, IC, before the registration number signifies that registration was performed based on a Declaration of Conformity indicating that Industry Canada technical specifications were met. It does not imply that Industry Canada approved the equipment.

The Ringer Equivalence Number (REN) for this terminal equipment is 0.1.

“The Ringer Equivalence Number is an indication of the maximum number of devices allowed to be connected to a telephone interface. The termination on an interface may consist of any combination of devices subject only to the requirement that the sum of the RENs of all devices does not exceed five.”

DOC Registration Number: IC: 1736A-4530A

Notice:

DoorKing does not provide a power transformer on units sold into Canada. Use only transformers that are CSA listed to power the telephone entry system. 1802, 1803, 1808, 1810, 1833, 1834, 1835, 1838 and all "P" series systems require a 16.5-volt, 20 VA transformer. The models 1816, 1820 and 1837 require a 16.5-volt, 50 VA transformer. The model 1812 requires a 24-volt, 20 VA transformer.

General Information

- Prior to beginning the installation of the telephone entry system, we suggest that you become familiar with the instructions, illustrations, and wiring guidelines in this manual. This will help insure that your installation is performed in an efficient and professional manner.
- The proper installation of the telephone entry panel is an extremely important and integral part of the overall access control system. Check all local building ordinances and building codes prior to installing this system. Be sure your installation is in compliance with local codes.
- When used to control a door or pedestrian gate, try to locate the telephone entry system as near as possible to the entry point. The unit should be mounted on a rigid wall to prevent excessive shock and vibration from closing doors or gates. Continuous vibration and shock from slamming doors or spring-loaded pedestrian gates will damage the circuit board. **Under no circumstances should the unit be mounted directly to a moving door or gate.**
- **ADA mounting requirements for door control.** The mounting of the unit shall be in such a way that the LCD display is positioned so that it is readily visible to and usable by a person sitting in a wheelchair with an approximate eye level of 45 inches and shall comply with the following requirements:
 1. If mounted vertically or tipped no more than 30 degrees away from the viewer, the center line of the LCD shall be located a maximum of 52 inches above grade.
 2. If the clear floor space allows only forward approach to the system, the maximum high forward reach allowed is 48 inches above grade to the top of the keypad.
 3. If the high forward reach to the system is over an obstruction of greater than 20 inches but less than 25 inches, the maximum high forward reach allowed is 44 inches above grade to the top of the keypad.
 4. If the clear floor space allows parallel approach by a person in a wheelchair, the maximum high side reach shall be 54 inches above grade to the top of the keypad.
 5. If the high side reach is over an obstruction of 24 inches or less, the maximum high side reach allowed is 46 inches above grade to the top of the keypad.
- **When used to control a vehicular gate with an automatic gate operator, the telephone entry system must be mounted a minimum of ten (10) feet away from the gate and gate operator, or in such a way that a person cannot operate the entry system and/or touch the gate or gate operator at the same time.**
- Be sure that the system is installed so that it is not directly in the traffic lane. Goose neck mounting post and kiosks work well for these type systems. When planning where to locate the system, take into consideration traffic lane layouts, turn around lanes for rejected access, conduit runs, power availability, etc.
- Environmental factors must also be taken into account. Surface mount units are designed for direct outdoor installations, however it is preferable to protect them from direct exposure to driven rain or snow whenever possible. Flush mount and wall mount units must be protected from direct exposure to the elements. Be sure that ample lighting is provided so that guest can read both the directory and the operating instructions at night.
- This telephone entry system contains a number of static sensitive components that can be damaged or destroyed by static discharges during installation or use. Discharge any static prior to removing the circuit board from the lobby panel by touching a proper ground device.

Section 1 - Installation

1.1 General Information

The DoorKing Model 1820 telephone intercom system provides communication to, and control of, a door (or gate) for up to 1200 users without the need for a dedicated Central Office (C.O.) phone line. This eliminates monthly line charges and equipment lease payments to the telephone company. The system is used widely with housing authority projects and low income housing because the system will provide all building residents, whether they have central office phone service or not, with communication and control of the door or gate.

This manual describes the installation and wiring of the 1820 main and auxiliary control cabinets, and the RJ71C phone block(s) only. For installation instructions on the front lobby panel(s) that are to be used with the system, refer to the manual that is included with the lobby panel. The main and auxiliary cabinets should be mounted close to the RJ71C phone blocks required for interfacing the telephone lines with the system.

Central Office Phone Line.

Although a C.O. phone line is not required for normal system operation, having a C.O. line installed to the 1820 main control cabinet will allow the use of the advanced features of the system. It should be noted that this C.O. line is not used for normal lobby panel to resident communication and an access code is required to utilize the C.O. line. Additionally, if a PC programmable telephone entry system (DKS models 1833, 1834, 1835, 1837) is used as the lobby panel, installing the C.O. line will enable programming of the system from an off site location. Order your telephone line at least two weeks prior to the planned installation date. This will assure that a phone line is available when the unit is installed. The telephone company will require the following information from you:

Type:	Touch Tone, Loop Start
Ringer Equivalence:	0.0 A
Jack Type:	RJ11C
FCC Registration (US):	DUF6VT-12874-OT-T
DOC (Canada):	1736 4528 A

- Prior to starting the installation of this system, it is highly recommended that you become familiar with the illustrations, instructions and wiring diagrams in this manual.
- It is recommended that the local telephone company install and wire the RJ71C phone blocks required with this system.

1.1.1 Main and Auxiliary Cabinets

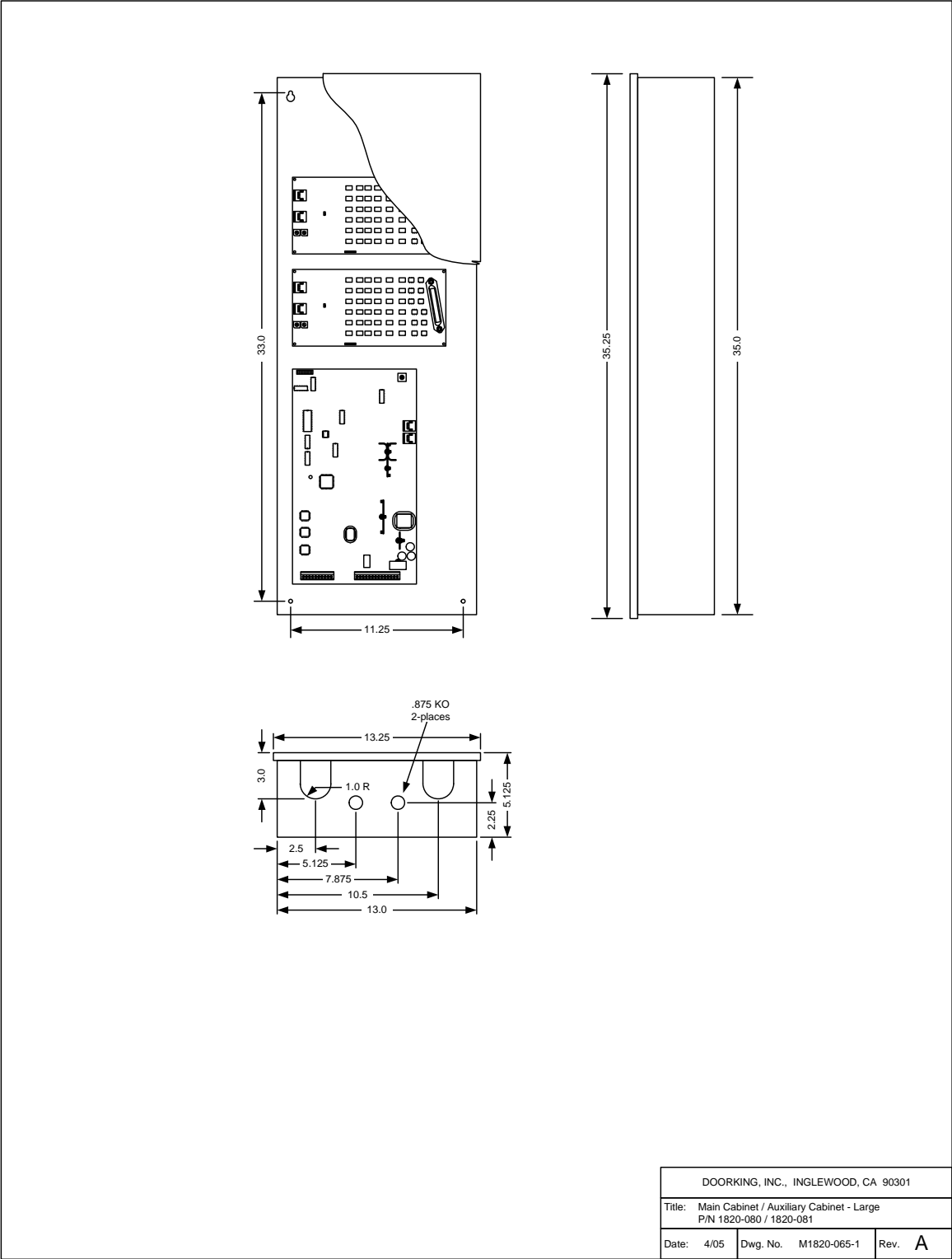

DOORKING, INC., INGLEWOOD, CA 90301			
Title: Main Cabinet / Auxiliary Cabinet - Large P/N 1820-080 / 1820-081			
Date: 4/05	Dwg. No. M1820-065-1	Rev. A	

1.1.2 Garden Style Cabinet

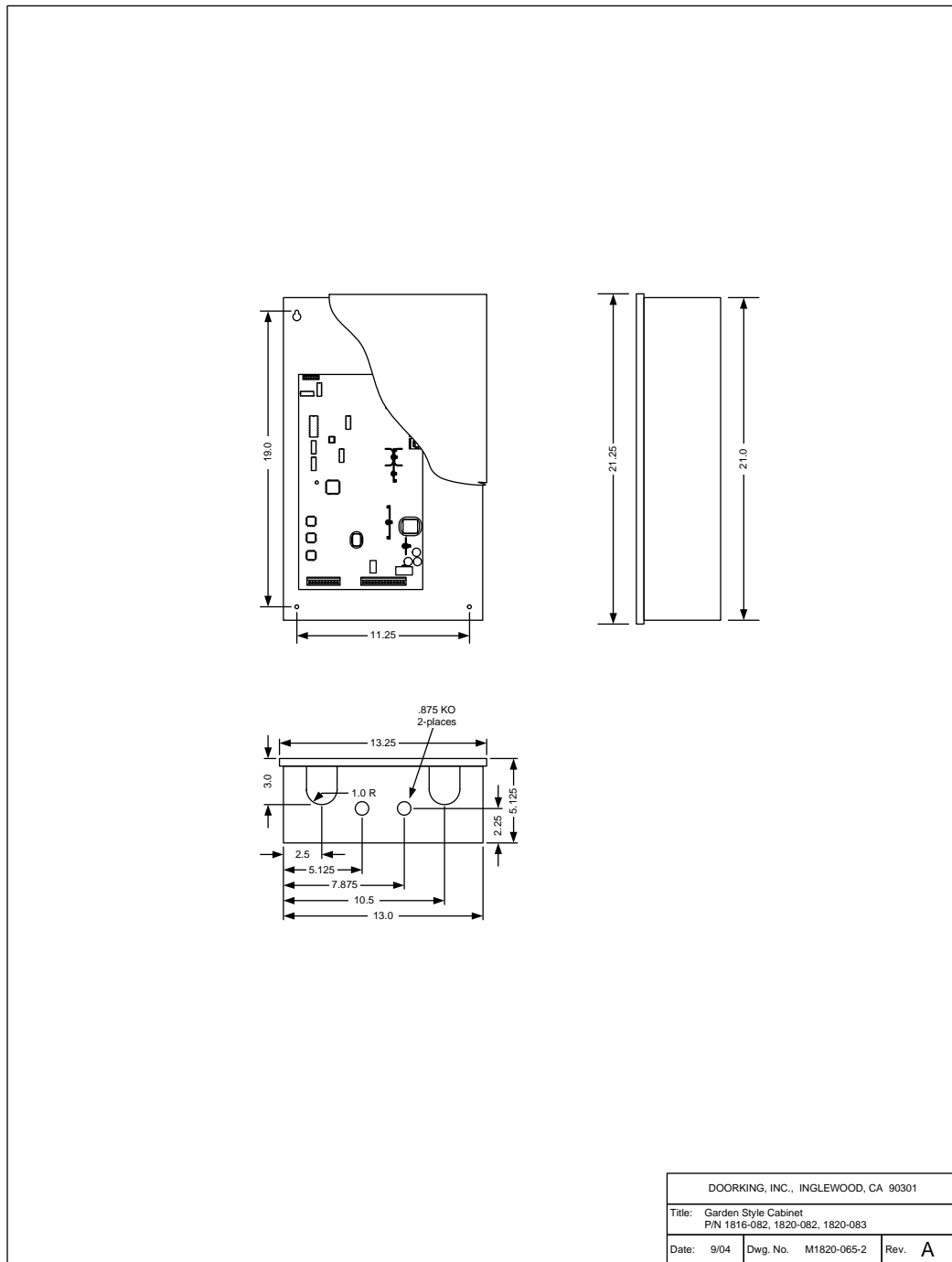

1.2 RJ71C Phone Block Installation

The RJ71C wiring configuration is not recognized by all telephone companies. For Bell Canada, which has jurisdiction for Ontario and Quebec, refer to CA-79X jack for interconnect to the 1820 system. For BC Tel, which has jurisdiction in British Columbia, refer to BC Tel CRTC Spec 182 B5.

1. Place the order for the RJ71C phone block installation with the local telephone company at least three weeks in advance of the 1820 system installation.
2. Order one (1) RJ71C block for every 12 telephone lines that the 1820 system will inter-connect with.
3. Have all required blocks installed in a common accessible location. This is usually near the original phone company termination board.
4. Be sure there the RJ71C blocks are mounted within 15 feet of where the main and auxiliary cabinet(s) are to be installed. The standard length connecting cable supplied by DoorKing is 15 feet. If longer cables are required, special length cables will have to be ordered at an additional cost.
5. **IMPORTANT!!** Complete the RJ71C block identification form in the back of this manual. This form instructs the telephone company installer how the phone lines should be wired to the RJ71C blocks. Make copies of the form if more are required.
6. **IMPORTANT!!** Be sure that the phone company installer labels the blocks! Each block should be numbered, and the phone number and apartment number should be written on the inside of the block cover (see example below).
7. Attach the RJ71C block identification form to the inside door of the 1820 cabinet after wiring is complete for future reference.
8. **CALL DOWN!!** For the call down feature and programming from the resident phone to function, the resident must have active telephone service. If the resident does not have active telephone service, then a special **Powered RJ-71C** (P/N 1820-047) phone block is needed. See section 2.3 for detail.

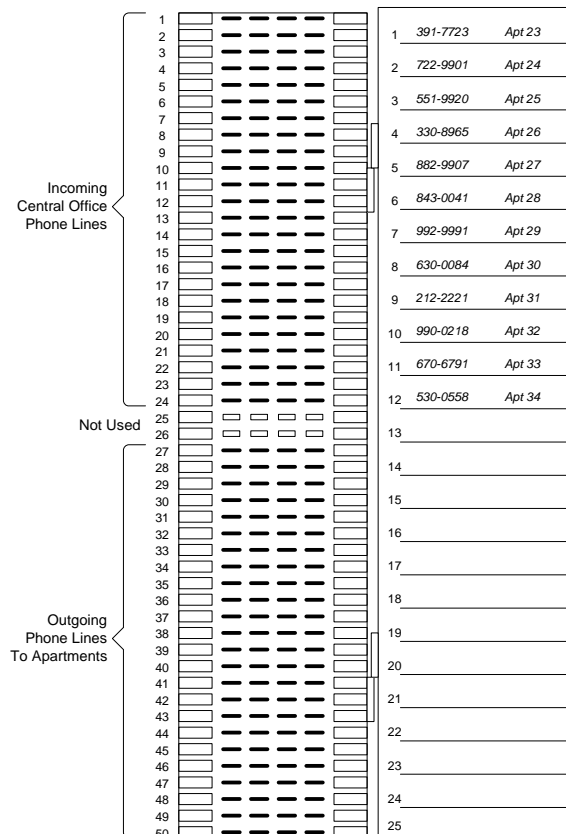

Incoming Central Office
Phone Lines - 12 Max

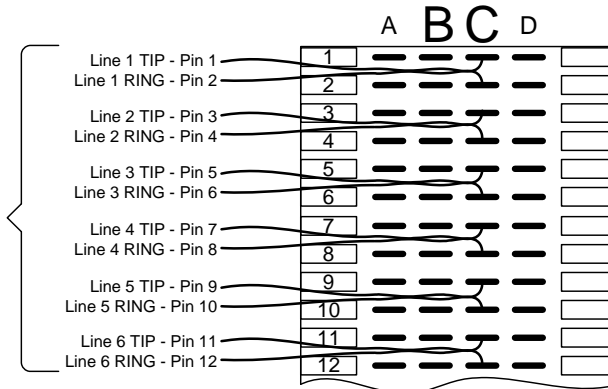

IMPORTANT!

When the phone wires are punched down on ROW B, bridge clips from row B to row C must be installed. If the phone wires are punched down on row C, bridge clips are not required.

IMPORTANT!

TIP (positive) RING (negative) polarity **MUST** be observed. TIP must be punched down on the top terminal of each pair and RING must be punched down on the bottom terminal of each pair.

Outgoing Phone Lines
to Apartments

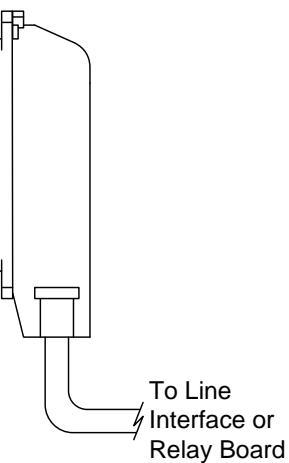
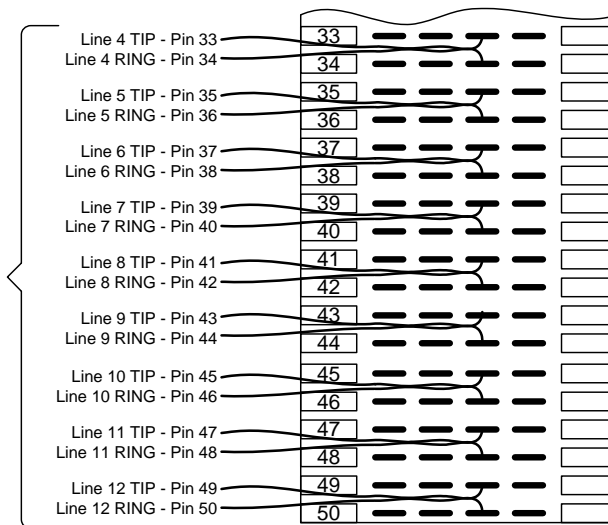

NOTE:

The RJ71C wiring configuration is not recognized by all telephone companies.

- For Bell Canada, which has jurisdiction in Ontario and Quebec, refer to CA-79X
- For BC Tel, which has jurisdiction in British Columbia, refer to BC Tel CRTC Spec 182 B5.

DOORKING, INC., INGLEWOOD, CA 90301			
Title: Detail Wiring - RJ71C Phone Block			
Date: 12/06	Dwg. No. M1816-065-6	Rev. C	

1.3 Cabinet, Relay and Component Identification

The Large Main Control Cabinet houses the main processor control board and up to 9 line interface boards. The Garden Style Main Control Cabinet houses the main processor control board and up to 4 line interface boards. Large Auxiliary Cabinets can hold up to 12 line interface boards and a power supply board. Garden Style Auxiliary Cabinets can hold up to 8 line interface boards.

1.3.1 Main Control Cabinet Options

If the 1820 system is interfacing with 48 or less phone lines, the Garden Style Cabinet is typically used since no auxiliary cabinets will be required. If the 1820 system is interfacing with more than 48, but less than 108 phone lines, then the larger 1820 Main Control Cabinet will be used.

1.3.2 Auxiliary Cabinet Options

Either garden style or large type cabinets can be used to hold additional line interface boards as required by the number of phone lines the system needs to interface with. The Garden Style Cabinet can hold up to 8 line interface boards, or 7 line interface boards and 1 power supply board. The Large Auxiliary Cabinet can hold up to 12 line interface boards and a power supply board.

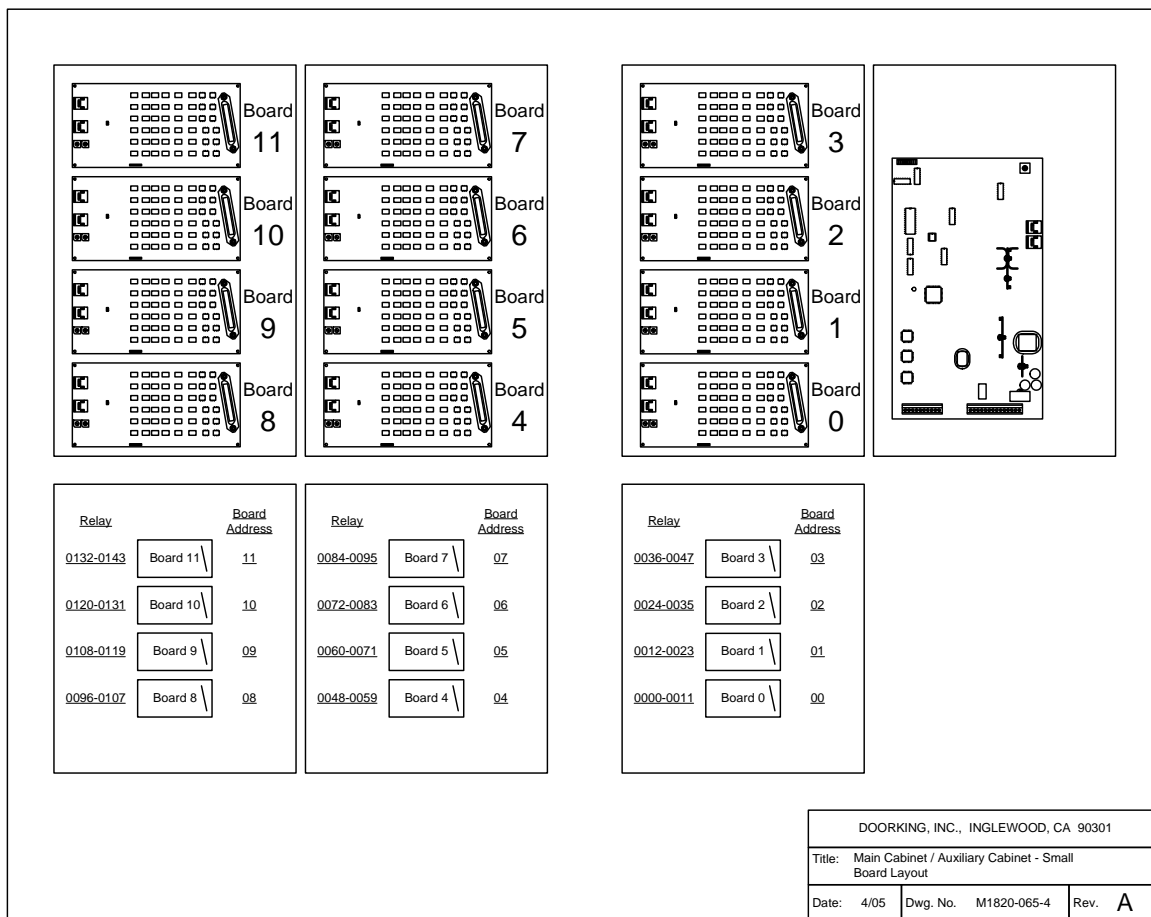

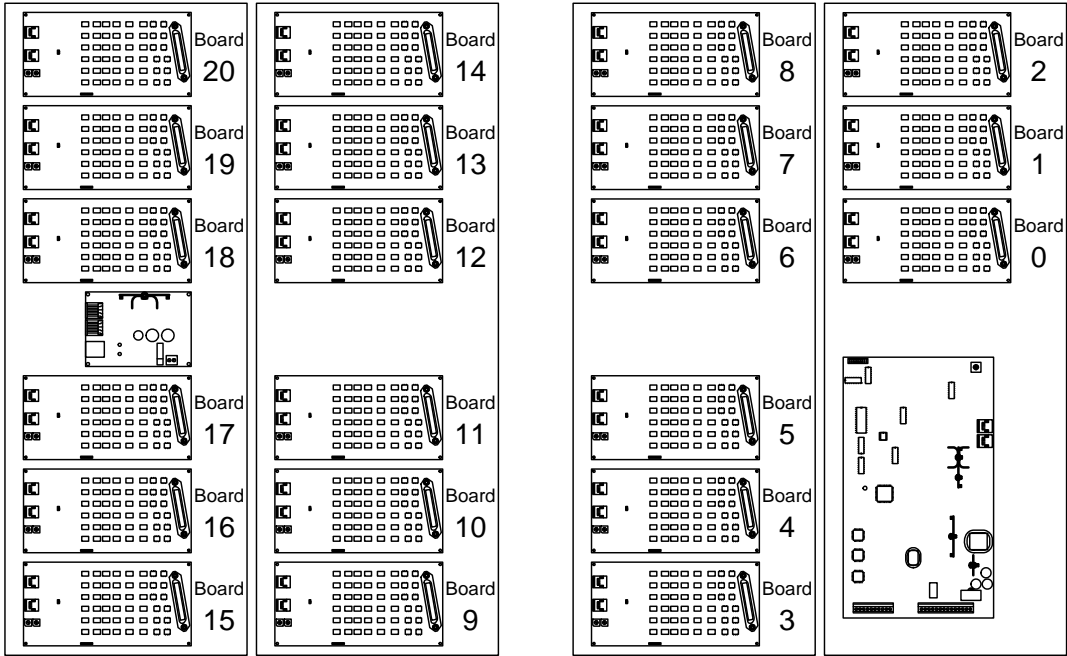

Relay	Board Address
0240-0251	Board 20 \ 20
0228-0239	Board 19 \ 19
0216-0227	Board 18 \ 18
	Power Module
0204-0215	Board 17 \ 17
0192-0203	Board 16 \ 16
0180-0191	Board 15 \ 15

Relay	Board Address
0168-0179	Board 14 \ 14
0156-0167	Board 13 \ 13
0144-0155	Board 12 \ 12
0132-0143	Board 11 \ 11
0120-0131	Board 10 \ 10
0108-0119	Board 9 \ 09

Relay	Board Address
0096-0107	Board 8 \ 08
0084-0095	Board 7 \ 07
0072-0083	Board 6 \ 06
0060-0071	Board 5 \ 05
0048-0059	Board 4 \ 04
0036-0047	Board 3 \ 03

Relay	Board Address
0024-0035	Board 2 \ 02
0012-0023	Board 1 \ 01
0000-0011	Board 0 \ 00

DOORKING, INC., INGLEWOOD, CA 90301			
Title: Main Cabinet / Auxiliary Cabinet - Large Board Layout			
Date: 4/05	Dwg. No. M1820-065-3	Rev. A	

1.3.3 Line Interface Boards

Each Line Interface Board has 12 relays on it that are referred to as relays 00 through 11. One line interface board is required for every 12 phone lines that the system interfaces with. These relays are identified to the main processor as a four digit relay number beginning with 0000 and increasing sequentially up to the maximum of 1199. A maximum of 100 line interface boards can be installed per system. Each cabinet has a label which identifies the cabinet number and the system relay numbers.

- Line interface boards in the main cabinet are numbered 0 – 2. Line interface board 0 is at the bottom, line interface board 2 is at the top.
- Each interface board is addressed using the two rotary switches on the board. The two 10 position switches allow for up to 100 board addresses starting at 00 and ending at 99. You cannot skip an address location. For example, if you have 7 interface boards in the system, the boards must be addressed from 00 (1st board) to 06 (7th board).
- If a line interface board is replaced, be sure to set the address on the new board correctly. Disconnect power to the main control board and then reapply for the change to take affect.

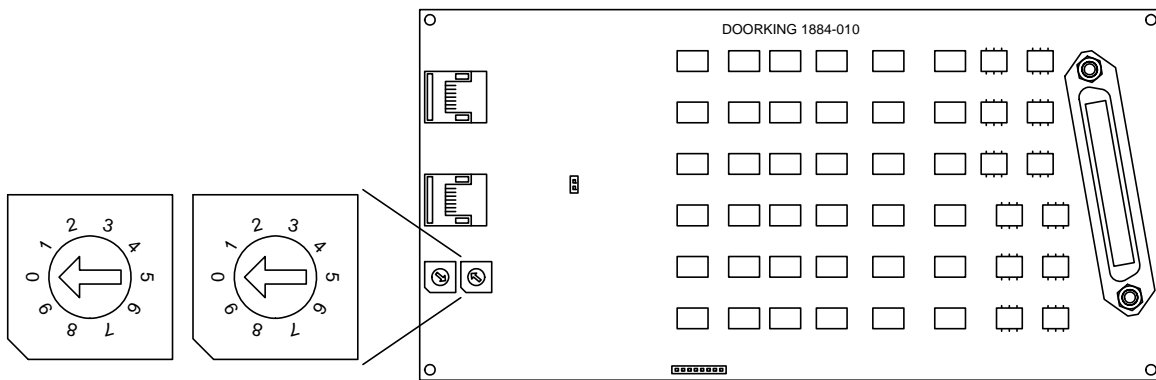

1.3.4 Power Supply Boards

The main control board can supply power for up to 21 line interface boards located within 200 feet of the main board. Additional line interface boards are powered by the addition of power supply boards, each capable of supplying power for up to an additional 21 line interface boards.

- If the distance from the main control board to the line interface boards exceeds 200 feet, additional power supply boards will be required to supply power to the line interface boards.

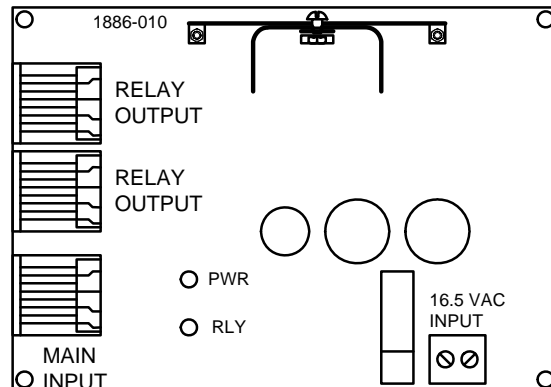

Board #	Board Address	1 st Relay	Last Relay		Board #	Board Address	1 st Relay	Last Relay
0	00	0000	0011		51	51	0612	0623
1	01	0012	0023		52	52	0624	0635
2	02	0024	0035		53	53	0636	0647
3	03	1136	0047		54	54	0648	0659
4	04	0048	0059		55	55	0660	0671
5	05	0060	0071		56	56	0672	0683
6	06	0072	0083		57	57	0684	0695
7	07	0084	0095		58	58	0696	0707
8	08	0096	0107		59	59	0708	0719
9	09	0108	0119		60	60	0720	0731
10	10	0120	0131		61	61	0732	0743
11	11	0132	0143		62	62	0744	0755
12	12	0144	0155		63	63	0756	0767
13	13	0156	0167		64	64	0768	0779
14	14	0168	0179		65	65	0780	0791
15	15	0180	0191		66	66	0792	0803
16	16	0192	0203		67	67	0804	0815
17	17	0204	0215		68	68	0816	0827
18	18	0216	0227		69	69	0828	0839
19	19	0228	0239		70	70	0840	0851
20	20	0240	0251		71	71	0852	0863
21	21	0252	0263		72	72	0864	0875
22	22	0264	0275		73	73	0876	0887
23	23	0276	0287		74	74	0888	0899
24	24	0288	0299		75	75	0900	0911
25	25	0300	0311		76	76	0912	0923
26	26	0312	0323		77	77	0924	0935
27	27	0324	0335		78	78	0936	0947
28	28	0336	0347		79	79	0948	0959
29	29	0348	0359		80	80	0960	0971
30	30	0360	0371		81	81	0972	0983
31	31	0372	0383		82	82	0984	0995
32	32	0384	0395		83	83	0996	1007
33	33	0396	0407		84	84	1008	1019
34	34	0408	0419		85	85	1020	1031
35	35	0420	0431		86	86	1032	1043
36	36	0432	0443		87	87	1044	1055
37	37	0444	0455		88	88	1056	1067
38	38	0456	0467		89	89	1068	1079
39	39	0468	0479		90	90	1080	1091
40	40	0480	0491		91	91	1092	1103
41	41	0492	0503		92	92	1104	1115
42	42	0504	0515		93	93	1116	1127
43	43	0516	0527		94	94	1128	1139
44	44	0528	0539		95	95	1140	1151
45	45	0540	0551		96	96	1152	1163
46	46	0552	0563		97	97	1164	1175
47	47	0564	0575		98	98	1176	1187
48	48	0576	0587		99	99	1188	1199
49	49	0588	0599					
50	50	0600	0611					

Section 2 - Wiring

Prior to installing wiring to the telephone entry system, we suggest that you become familiar with the instructions, illustrations, and wiring guidelines in this manual. This will help insure that you installation is performed in an efficient and professional manner. This telephone entry system contains a number of static sensitive components that can be damaged or destroyed by static discharges during installation or use. Discharge any static prior to removing the circuit board from the lobby panel by touching a proper ground device.

The wiring of the telephone entry panel is an extremely important and integral part of the overall access control system. Use proper wire for the communication line, power wires, and be sure that the system is properly grounded. Check all local building ordinances and building codes prior to installing this system. Be sure your installation is in compliance with local codes.

Use only the supplied transformers (or U.L. listed equivalent) to power the telephone entry system (16.5 VAC, 50 VA). Do not power any other devices (electric strikes, magnetic locks, etc.) from this power transformer. For wire runs up to 100 feet, use 18 AWG, 600 volt insulated wire. For wire runs up to 200 feet, use 16 AWG, 600 volt insulated wire.

- Use 18 AWG wire for power runs up to 100 feet.
- Use 16 AWG wire for power runs up to 200 feet.
- Surge protection is recommended. Use DKS P/N 1878-010 or equivalent.
- Use only twisted pair wires for phone line wiring. 24 AWG for up to 800 feet; 22 AWG up to 1600 feet.
- Electric strikes, magnetic locks, etc., must be powered by a separate power transformer.
- Lobby panels are powered from a separate power transformer.

This telephone intercom system requires the use of RJ71C phone blocks. We recommend that you have the local telephone company install these blocks for you. One RJ71C must be ordered for every 12 phone lines (or fraction there of) that the 1820 will interface with. Give the telephone company plenty of advance notice of when you will need the blocks installed. You must complete the RJ71C block identification form(s) in the back of this manual. This is very important as it instructs the phone company installer how the phone lines should be wired to the RJ71C. Be sure that the phone company installer labels the blocks. Each block should be numbered, and the telephone number and apartment number should be written on the inside of the block cover (see example on page xx). When the phone company installer has completed the RJ71C block identification form(s), attach the form to the inside of the 1816 cabinet for future reference.

The RJ71C wiring configuration is not recognized by all telephone companies. For Bell Canada (Ontario, Quebec), refer to CA-79X block for interconnection to the 1816 system. For BC Tel (British Columbia), refer to BC Tel CRTC Spec 182 B5.

Lobby panels come with their own wiring diagrams. The only connection between the 1820 and the lobby panel is a twisted pair telephone wire.

2.1 Wiring Detail – Garden Style Cabinet

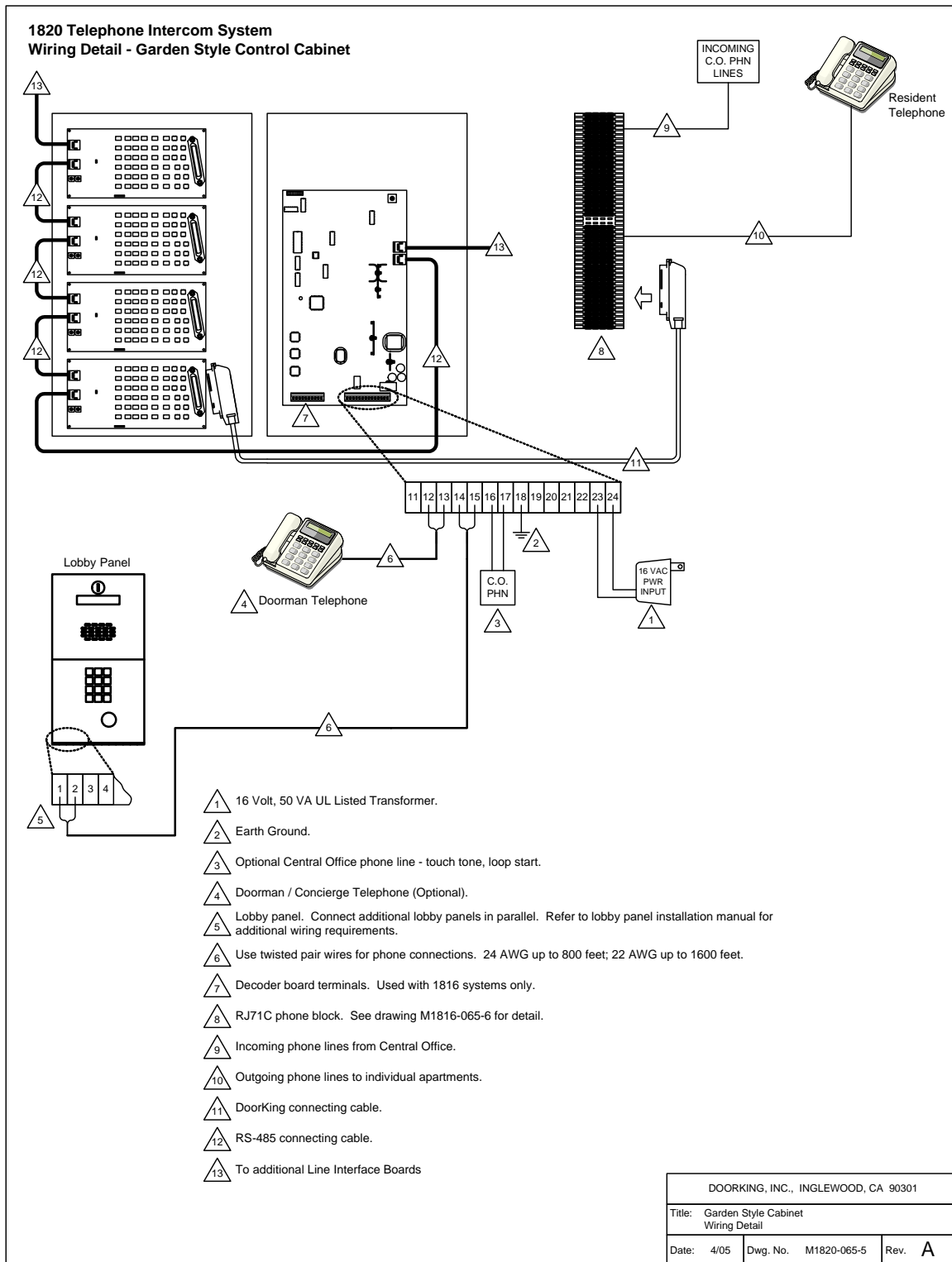

2.2 Wiring Detail – Large Main Cabinet

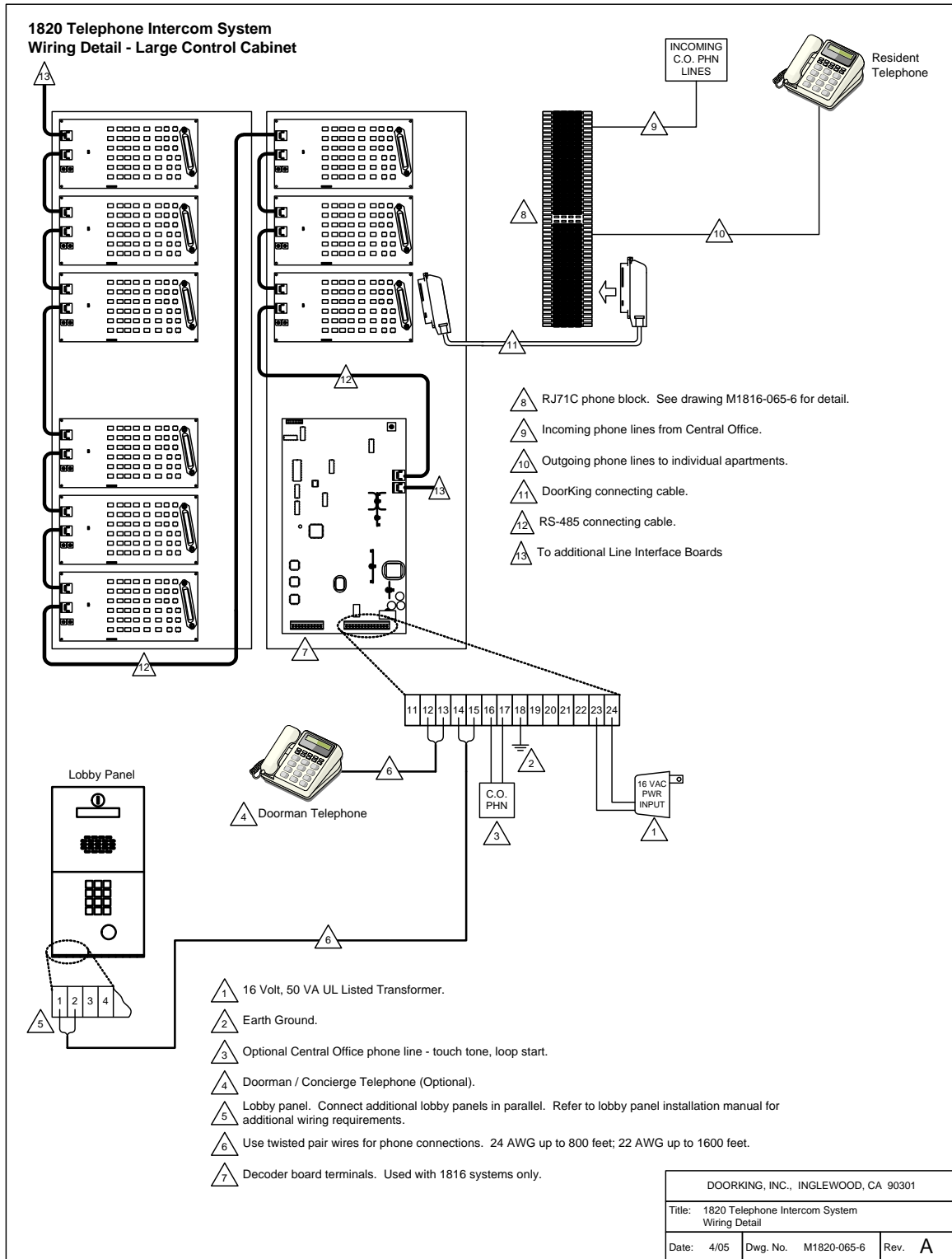

2.2.1 Wiring Detail – Auxiliary Cabinets

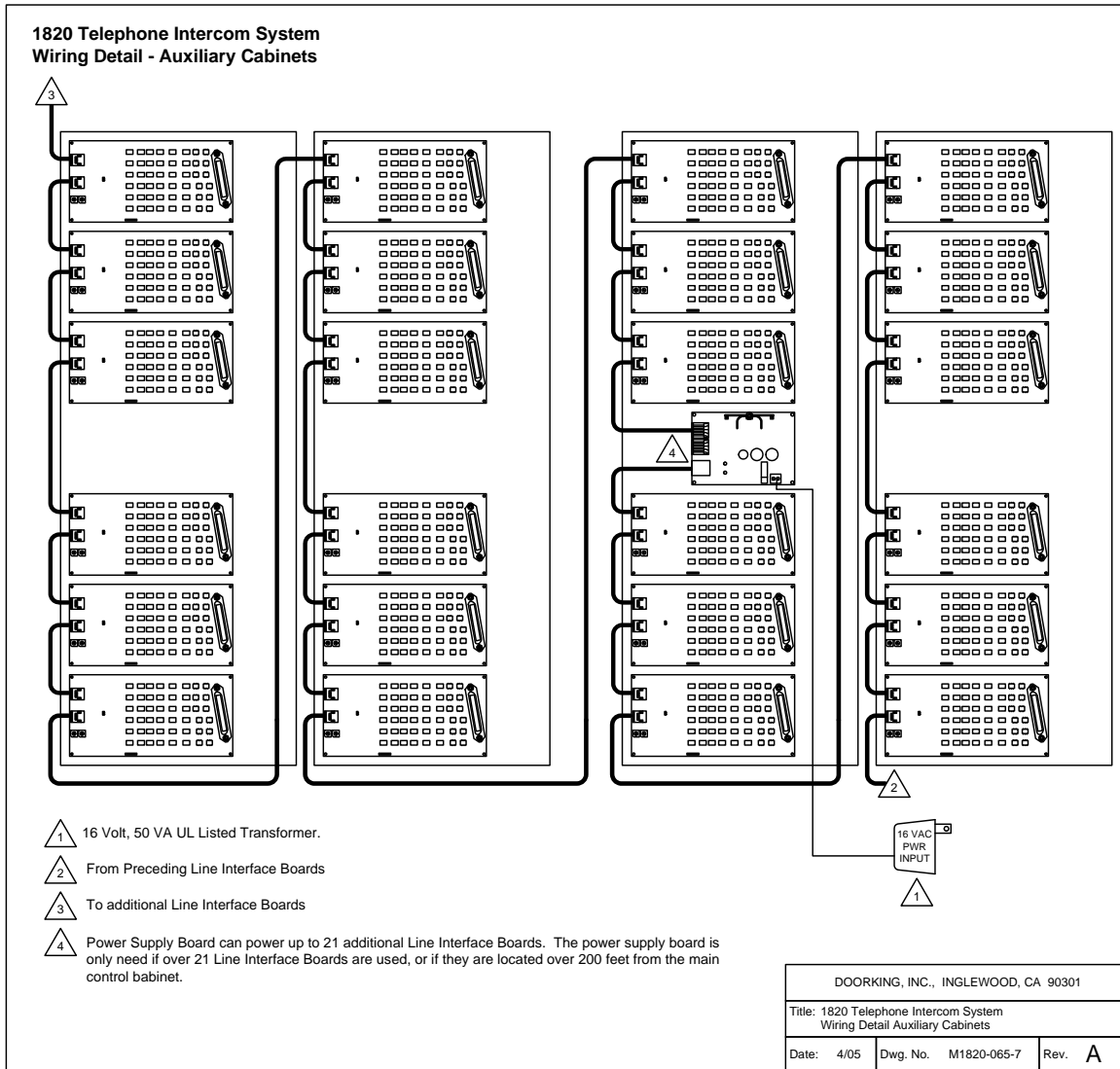

2.3 Powered RJ-71C Wiring

For the Call Down feature and programming from a resident telephone to function in this system, the resident must have an active Central Office (C.O.) phone line. The C.O. phone line provides the power for these features to operate. If a resident does not have an active C.O. phone line, then a special **POWERED RJ-71C** (P/N 1820-047) phone block will have to be used.

Depending on the application, some residents may have an active C.O. phone line while others may not. You should also consider that this could change in the future. If a resident changes status of having active C.O. phone service, or not having active C.O. phone service, the phone line will need to be physically changed from a standard RJ-71C phone block to a powered RJ-71C phone block, and vice-versa. There are two options for wiring a powered RJ-71C block into the system.

2.3.1 Dual Line Interface Board Option

Refer to drawing 1820-065-8.

Benefits:

- Does not require moving any telephone company phone wiring.

Disadvantages:

- Requires additional Line Interface Boards. This must be factored into the equipment list and the hardware is configured.
- Resident directory code / system relay number will change when phone wiring is removed.
- If programmable directory codes are in use, the directory code will need to be reprogrammed.
- Requires 1 extra Line Interface Board for every 12 phone lines without Central Office phone service.

2.3.2 Dual RJ-71C Option

Refer to drawing 1820-065-9

Benefits:

- Additional Line Interface Boards are not required.
- Resident directory code / system relay number does not change.
- Does not require reprogramming when a resident's telephone service status changes.

Disadvantages:

- Requires disconnect of the telephone company wiring.

**1820 Telephone Intercom System
Wiring Detail - Powered RJ-71C / Dual Interface Boards**

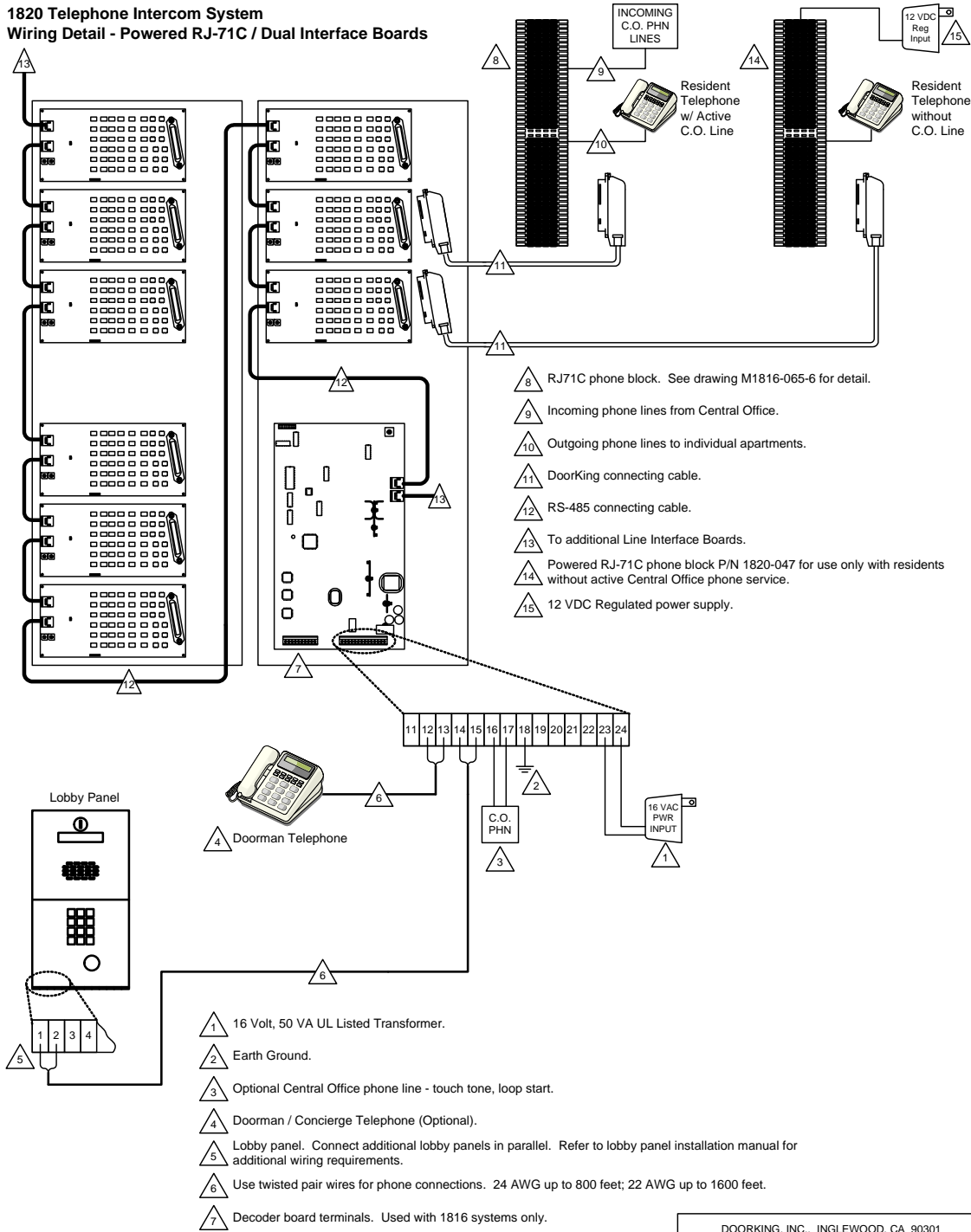

- ▲ 8 RJ71C phone block. See drawing M1816-065-6 for detail.
- ▲ 9 Incoming phone lines from Central Office.
- ▲ 10 Outgoing phone lines to individual apartments.
- ▲ 11 DoorKing connecting cable.
- ▲ 12 RS-485 connecting cable.
- ▲ 13 To additional Line Interface Boards.
- ▲ 14 Powered RJ-71C phone block P/N 1820-047 for use only with residents without active Central Office phone service.
- ▲ 15 12 VDC Regulated power supply.

- ▲ 1 16 Volt, 50 VA UL Listed Transformer.
- ▲ 2 Earth Ground.
- ▲ 3 Optional Central Office phone line - touch tone, loop start.
- ▲ 4 Doorman / Concierge Telephone (Optional).
- ▲ 5 Lobby panel. Connect additional lobby panels in parallel. Refer to lobby panel installation manual for additional wiring requirements.
- ▲ 6 Use twisted pair wires for phone connections. 24 AWG up to 800 feet; 22 AWG up to 1600 feet.
- ▲ 7 Decoder board terminals. Used with 1816 systems only.

DOORKING, INC., INGLEWOOD, CA 90301		
Title: 1820 Telephone Intercom System Wiring Detail for Powered RJ-71C / Dual Boards		
Date: 4/05	Dwg. No. M1820-065-8	Rev. A

**1820 Telephone Intercom System
Wiring Detail - Dual RJ-71C Option**

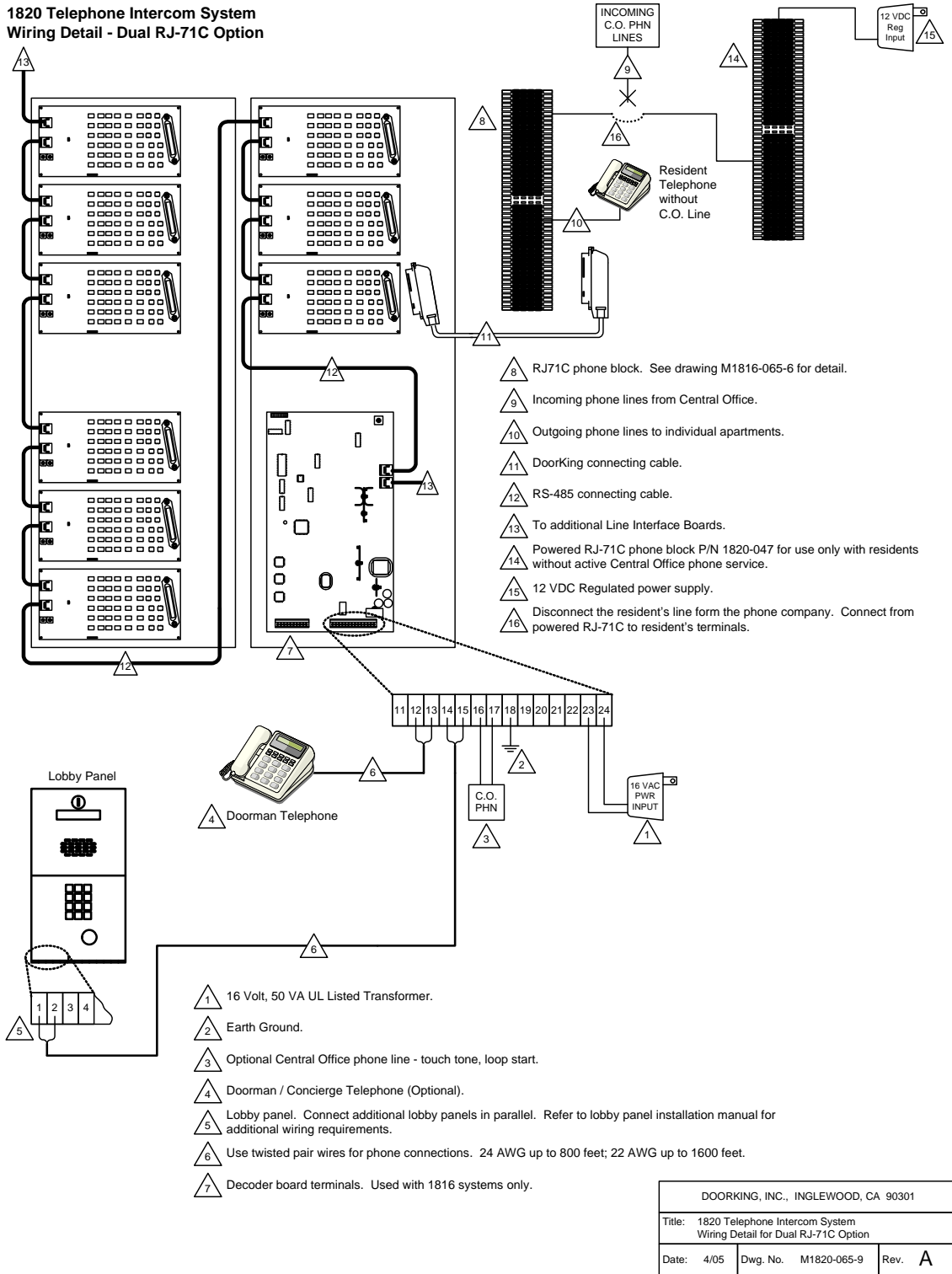

- 8 RJ71C phone block. See drawing M1816-065-6 for detail.
- 9 Incoming phone lines from Central Office.
- 10 Outgoing phone lines to individual apartments.
- 11 DoorKing connecting cable.
- 12 RS-485 connecting cable.
- 13 To additional Line Interface Boards.
- 14 Powered RJ-71C phone block P/N 1820-047 for use only with residents without active Central Office phone service.
- 15 12 VDC Regulated power supply.
- 16 Disconnect the resident's line form the phone company. Connect from powered RJ-71C to resident's terminals.

- 1 16 Volt, 50 VA UL Listed Transformer.
- 2 Earth Ground.
- 3 Optional Central Office phone line - touch tone, loop start.
- 4 Doorman / Concierge Telephone (Optional).
- 5 Lobby panel. Connect additional lobby panels in parallel. Refer to lobby panel installation manual for additional wiring requirements.
- 6 Use twisted pair wires for phone connections. 24 AWG up to 800 feet; 22 AWG up to 1600 feet.
- 7 Decoder board terminals. Used with 1816 systems only.

DOORKING, INC., INGLEWOOD, CA 90301			
Title: 1820 Telephone Intercom System Wiring Detail for Dual RJ-71C Option			
Date: 4/05	Dwg. No. M1820-065-9	Rev. A	

2.4 Circuit Board Connector Locations

10-Pin Ribbon Connector
 Use with 1882 and 1982
 (Standard) Relay Boards
 1816 Systems only

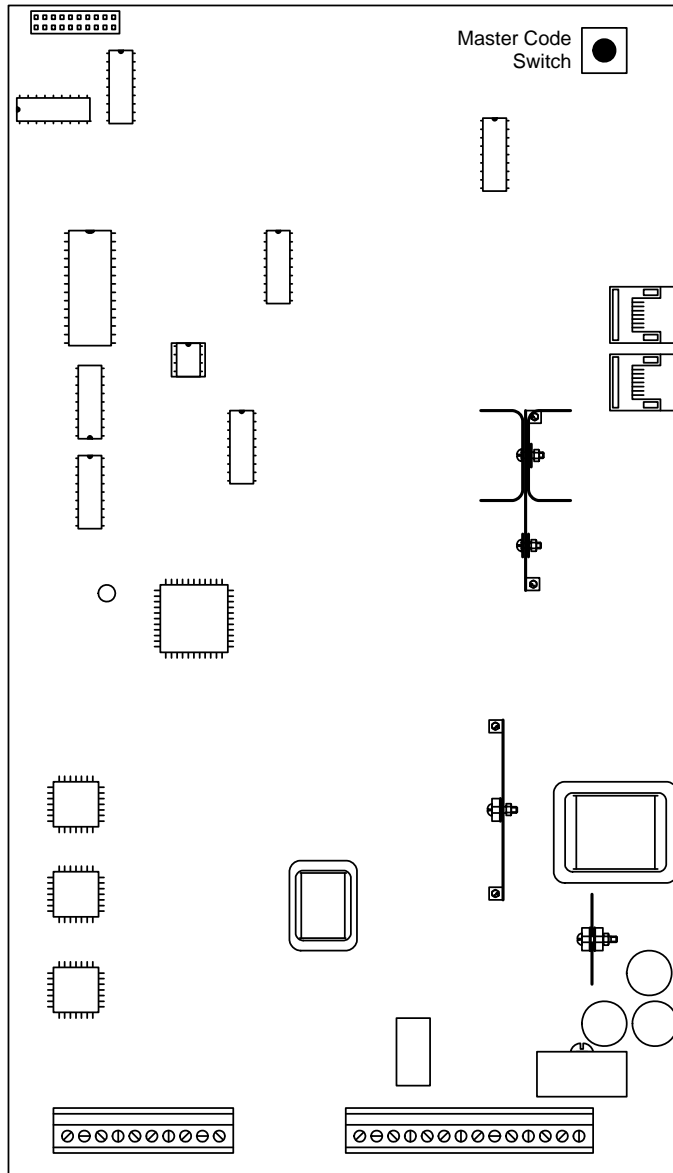

RJ45 Jacks
 Use with 1884 (Call Down)
 Line Interface Boards
 1820 Systems Only

Terminals 1-10
 Decoder Board Connection
 1816 Systems only

Main Terminals 11-24

2.5 Main Circuit Board Terminal Description

Terminal	Description
1	Decoder Board Connection. Decoder boards are required with 1816 systems that use more than 5 relay boards.
2	
3	
4	
5	
6	
7	
8	
9	
10	
11	Postal Switch – A switch closure across terminals 11 and 24 will cause the relay on the 1885 board to activate for its programmed strike time.
12	Doorman / Concierge Telephone
13	Doorman / Concierge Telephone
14	Lobby Panel Entry System or Telephone
15	Lobby Panel Entry System or Telephone
16	Central Office Phone Line (Optional)
17	Central Office Phone Line (Optional)
18	Earth Ground
19	Relay Normally Closed (NC) Contact
20	Relay Normally Open (NO) Contact
21	Relay Common Contact
22	Not Used
23	16 VAC Main Cabinet Power Input
24	Low Voltage Common

Section 3 – Programming

3.1 System Set Up

The system has default settings for most programming functions. When installing a new system, there is some set up programming required which will format the system to meet the operational requirements of the installation. Once the system is set up, there are also operational programming steps for the Doorman/Concierge phone and for tenant phones.

- Programming steps for the 1820 set up are performed from the doorman/concierge phone or from a standard touch tone phone connected to the lobby panel terminals (14-15). A “BEEP” in the handset confirms that the programming step has been completed successfully. Do not use a telephone with the keypad on the handset.
- Resident telephones are addressed either by the system relay number or by a programmed directory code. This is an either/or scenario. All residents will either use the default system relay number or all residents will be assigned a programmed directory code.
- The system wide commands that turn features ON/OFF can be very useful when troubleshooting. These commands will not delete or erase any programmed information. They simply disable the feature for system users.
- It is highly recommended that you make a record of ALL programming completed. You can complete the blanks in this instruction booklet and/or use the tables provided in the appendix of this manual.

3.1.1 Master Code

This must be set at the 1885-010 Main Control Board. It is the “Password” utilized in all programming steps.

Factory Default = 9999

1. Press the Master Code button on the main control board (upper right hand corner). The power LED will start blinking slowly.
2. On the doorman telephone, enter a four-digit master code _ _ _ _ then press * (beep). The LED will stop blinking.
3. Hang up to end the programming session.

3.1.2 1982 Relay Board / 1884 Interface Board

The 1885 main control board can be programmed to operate as an 1816 system utilizing the 1982 Relay Boards, or it can be programmed to operate as an 1820 system utilizing the 1884 Line Interface Boards. This programming step tells the 1885 board which type system is in use and **must be programmed for 1884 Line Interface Boards with the 1820 system.**

Factory Default = 0 (1982 Relay Boards) Enter “1” in step 3 for 1884 Line Interface Board.

1. Take the doorman telephone off hook.
2. Press *54 and enter the four-digit MASTER CODE _ _ _ _ (beep).
3. Enter 1 then press * (beep).
4. Hang up the doorman telephone to end the programming session.

3.1.3 Last Available Relay

The 1820 is capable of working with up to 1200 telephones, i.e. it can select one of up to 1200 system relays that are numbered 0000 through 1199. You must program into the system the last relay number that is available. Determine how many relay boards are connected to the system, then using the chart below, select the last available relay. For example, if your system uses 55 relay boards, the last relay available is 0671.

Factory Default = 0011

1. Take the doorman telephone off hook.
2. Press *07 and enter the four-digit MASTER CODE _ _ _ _ (beep).
3. Enter the four-digit last available relay number _ _ _ _ then press * (beep).
4. Hang up the doorman telephone to end the programming session.

Board Number	1 st Relay	Last Relay
0	0000	0011
1	0012	0023
2	0024	0035
3	0036	0047
4	0048	0059
5	0060	0071
6	0072	0083
7	0084	0095
8	0096	0107
9	0108	0119
10	0120	0131
11	0132	0143
12	0144	0155
13	0156	0167
14	0168	0179
15	0180	0191
16	0192	0203
17	0204	0215
18	0216	0227
19	0228	0239
20	0240	0251
21	0252	0263
22	0264	0275
23	0276	0287
24	0288	0299

Board Number	1 st Relay	Last Relay
25	0300	0311
26	0312	0323
27	0324	0335
28	0336	0347
29	0348	0359
30	0360	0371
31	0372	0383
32	0384	0395
33	0396	0407
34	0408	0419
35	0420	0431
36	0432	0443
37	0444	0455
38	0456	0467
39	0468	0479
40	0480	0491
41	0492	0503
42	0504	0515
43	0516	0527
44	0528	0539
45	0540	0551
46	0552	0563
47	0564	0575
48	0576	0587
49	0588	0599

Board Number	1 st Relay	Last Relay
50	0600	0611
51	0612	0623
52	0624	0635
53	0636	0647
54	0648	0659
55	0660	0671
56	0672	0683
57	0684	0695
58	0696	0707
59	0708	0719
60	0720	0731
61	0732	0743
62	0744	0755
63	0756	0767
64	0768	0779
65	0780	0791
66	0792	0803
67	0804	0815
68	0816	0827
69	0828	0839
70	0840	0851
71	0852	0863
72	0864	0875
73	0876	0887
74	0888	0899

Board Number	1 st Relay	Last Relay
75	0900	0911
76	0912	0923
77	0924	0935
78	0936	0947
79	0948	0959
80	0960	0971
81	0972	0983
82	0984	0995
83	0996	1007
84	1008	1019
85	1020	1031
86	1032	1043
87	1044	1055
88	1056	1067
89	1068	1079
90	1080	1091
91	1092	1103
92	1104	1115
93	1116	1127
94	1128	1139
95	1140	1151
96	1152	1163
97	1164	1175
98	1176	1187
99	1188	1199

3.1.4 Setting the System Time Clock

This programming sequence sets the internal time clock in the 1820 system. (Note – if you only want to set the time, you can stop after step 4).

Factory Default = (Not Programmed)

1. Take the doorman telephone off hook.
2. Press *33 and enter the four-digit MASTER CODE ____ (beep).
3. Enter the hour and minutes (HHMM) ____ then press * (beep).
4. Enter 0 for AM; or enter 1 for PM _ then press * (beep).
5. Enter the month, day and year (MMDDYY) _____ then press * (beep).
6. Enter the day of the week (1=Sunday, 7=Saturday) _ then press *(beep).
7. Hang up the doorman telephone to end the programming session.

3.1.5 Set the Caller ID Number

The system will provide a Caller ID to the resident phone when a call is generated from either the entry panel or the doorman/concierge phone. This is necessary because some telephones equipped with caller ID functions will not work unless a phone number is displayed. The caller ID number may be set to anything, it has no other function.

Factory Default = 1234567890

1. Take the doorman telephone off hook.
2. Press *41 and enter the four-digit MASTER CODE ____ (beep).
3. Enter the 10-digit caller ID number ____ then press * (beep).
4. Hang up the doorman telephone to end the programming session.

3.1.6 Set the Talk Time

Talk time is the length of time that the 1820 system will allow communication to take place before disconnecting. Talk time is set using a three digit code to set the time in seconds. Talk time can be set from 001 to 255 seconds.

NOTE: When a DoorKing lobby panel is connected to the system, talk time should be set to 255 seconds. The lobby panel talk time should be set to the desired time and will override the talk time set here. Refer to the lobby panel programming instructions to set the lobby panel talk time.

Factory Default = 060

1. Take the doorman telephone off hook.
2. Press *08 and enter the four-digit MASTER CODE ____ (beep).
3. Enter the three-digit talk time in seconds (001 – 255) ____ then press * (beep).
4. Hang up the doorman telephone to end the programming session.

3.1.7 Number of Rings / Ring Type

This programming sequence sets up the 1820 system for: 1) the number of rings allowed before the system automatically hangs up if the call is not answered, 2) a single or double ring (when set for double ring, the first ring will be a single ring). A two digit number will be entered to set up these operating parameters, with each number of the code corresponding to the respective functions listed.

Factory Default = 31

1. Take the doorman telephone off hook.
2. Press *04 and enter the four-digit MASTER CODE _ _ _ _ (beep).
3. Enter the two-digit ring/ring type code _ _ then press * (beep).
4. Hang up the doorman telephone to end the programming session.

Code Digit	Number	Description
1 st	2 - 9	The number of rings before the 1820 automatically hangs up.
2 nd	0 or 1	Enter 0 for a standard single ring, or enter 1 for a double ring.

3.1.8 Tone Open Number Programming

The tone open number is the number that is pressed on the resident's telephone to activate the relay on the 1885 control board. The resident can only activate the relay momentarily, but other relay functions are available from the doorman/concierge phone and by remote relay activation. The four relay functions are: 1) momentary activation, 2) continuous activation (relay latch), 3) deactivation (unlatch), 4) activate for one hour, then automatically deactivate. If a function is not going to be used, enter a # sign in place of the respective digit. Do not use the number "3" as a tone open number since this number is reserved to activate the call waiting feature. Do not duplicate tone open numbers.

NOTE: When used with a DoorKing Lobby Panel, the 1820 and lobby panel Tone Open Number programming must match. Refer to the lobby panel programming instructions to program the lobby panel Tone Open Number programming.

Factory Default = 9 # # #

1. Take the doorman telephone off hook.
2. Press *05 and enter the four-digit MASTER CODE _ _ _ _ (beep).
3. Enter the four-digit tone code _ _ _ _ then press * (beep).
4. Hang up the doorman telephone to end the programming session.

Code Digit	Number	Description
1 st	0, 1, 2, 4-9	Activate the relay for the programmed strike time.
2 nd		Activates the relay continuously (relay latch).
3 rd		Deactivates the relay (relay unlatch).
4 th		Activates relay for 1-hour, then automatically deactivates.

3.1.9 Relay Strike Time

The relay strike time is the amount of time that the relay on the 1885 control board will be energized when activated by a tone open number, entry code number, or key switch (postal lock) input. Typical strike time is 5 seconds for an electric strike or magnetic lock release.

Factory Default = 01

1. Take the doorman telephone off hook.
2. Press *03 and enter the four-digit MASTER CODE _ _ _ _ (beep).
3. Enter the two-digit strike time code (00 – 99) _ _ then press * (beep). Note: 00 = ¼ sec.
4. Hang up the doorman telephone to end the programming session.

3.2 Directory Codes

The four digit directory code is the number that is entered on the doorman/concierge or on the lobby telephone keypad to communicate with a particular tenant in the building. The directory codes start at 0000 and increase sequentially up to the maximum number of relays being used in the system. For example, if 100 residents are connected to the 1820 system, the directory codes being used will be 0000 for the first resident, up to 0099 for the 100th resident. Directory code 0000 activates system relay 0000 and makes a connection to the resident connected to this relay, directory code 0001 activates system relay 0001 and makes a connection to the second resident, and so on.

The programmable directory code feature allows any four digit code between the numbers of 0000 and 3131 to be used as a resident's directory code, regardless of which system relay the resident's telephone is connected to. For example, if a resident's telephone line is connected to system relay 0000, that resident's directory code can be programmed to any four digit number between 0000 and 3131. This feature is useful in applications, for instance, where apartment numbers are to be used as the directory code number. Caution must be exercised to not duplicate any directory codes. Log all directory codes entered into the system using the sample log sheet provided in the back of this manual. Make copies of the log sheets if more are required. When the programmable directory codes are turned "on", entering the programmed directory code will place the visitor in connection with the resident's telephone. Turning the programmable directory codes "off" requires that the system relay number be entered on the keypad to contact a resident. See Operating Instructions for more information.

3.2.1 Programming Directory Codes

These steps will allow the doorman/concierge to program directory codes for each resident. An 8-digit code (XXXXYYYY) is entered, where the first 4 digits (X) represent the programmed directory code and the last 4 digits (Y) represent the actual system relay number. For example, if directory code 1234 is programmed to activate system relay 0219, then the 8-digit code is: 12340219. It is suggested that you complete a log sheet with all the programmed codes showing which system relay the programmed code activates. **Programmable Directory Codes must be set to ON in step 3.2.2 for this to work.**

NOTE: Entering 9 9 9 9 in the system relay number will cause the 1820 to do nothing. This may be desired if for some reason certain system relays will not be used. For example, if 1 2 3 4 9 9 9 9 is entered in step 3, dial tone will be heard on the lobby panel speaker when 1 2 3 4 is entered on the lobby panel keypad. The visitor can then press any key to hang up the system.

NOTE: When programmable directory codes are used, all programming in any other programming function should use the programmed directory code and not the relay number.

Factory Default = (Not Programmed)

1. Take the doorman telephone off hook.
2. Press *14 and enter the four-digit MASTER CODE _ _ _ _ (beep).
3. Enter the eight-digit code _ _ _ _ _ _ _ _ then press * (beep).
4. Repeat step 3 to enter additional programmed directory codes. Remember to press * after each code entered.
5. Hang up the doorman telephone to end the programming session.

3.2.2 Turning Programmable Directory Codes On / Off

The programmable directory codes can be turned "ON" or "OFF" after they have been programmed. It will be necessary to turn this feature off if any trouble shooting of the system is ever required. Turning the programmable directory code feature off does not cause the system to erase any directory codes that have been previously programmed.

Factory Default = 1 (Off)

1. Take the doorman telephone off hook.
2. Press *13 and enter the four-digit MASTER CODE _ _ _ _ (beep).
3. Press 1 to turn this feature OFF; or press 0 to turn this feature ON then press * (beep). (1 = system will use system relay number for resident identification. 0 = each resident will be assigned a directory code.)
4. Hang up the doorman telephone to end the programming session.

3.2.3 Directory Code for Doorman/Concierge to Lobby Panel

This programmed directory code is used to initiate calls from the lobby panel directly to the doorman/concierge phone and vice-versa. Code must be between 4000 and 9999. Be sure that you do not duplicate outside line access codes (see section 3.3).

Factory Default = (Not Programmed)

1. Take the doorman telephone off hook.
2. Press *18 and enter the four-digit MASTER CODE _ _ _ _ (beep).
3. Enter a four-digit code (4000 – 9999) _ _ _ _ then press * (beep).
4. Hang up the doorman telephone to end the programming session.

3.2.4 Erasing All Programmed Directory Codes

This programming sequence will erase ALL programmed directory codes from the system. This command can take as long as 20 seconds to complete. During the erasing process, short beeps will be heard. When all directory codes are erased, a long beep will be heard. **Caution – this programming sequence is irreversible once it is started.**

1. Take the doorman telephone off hook.
2. Press *15 and enter the four-digit MASTER CODE _ _ _ _ (beep).
3. Enter 9 9 9 9 then press * (a long beeeeeep will be heard when complete).
4. Hang up the doorman telephone to end the programming session.

3.3 Dedicated Phone Line Access

An optional dedicated central office (C.O.) phone can be connected to the 1820 system. Connecting a C.O. line to the system provides additional functions available to the doorman/concierge and the lobby panel can be programmed to dial an outside line under certain circumstances. It also allows remote programming via a PC and modem when using a DoorKing 1833, 1834, 1835 or 1837 as the lobby panel.

3.3.1 Doorman/Concierge Outside Line Access

When the optional dedicated telephone line is connected to the 1820 system, the doorman may have unrestricted use of this line. This requires an access code to be entered on the doorman phone each time the doorman wants to access the outside line. Code must be between 4000 and 9999. Be sure that you do not duplicate doorman/concierge or lobby panel codes (see section 3.2.3).

Factory Default = (Not Programmed)

1. Take the doorman telephone off hook.
2. Press *09 and enter the four-digit MASTER CODE _ _ _ _ (beep).
3. Enter a four-digit access code (4000 – 9999) _ _ _ _ then press * (beep).
4. Hang up the doorman telephone to end the programming session.

3.3.2 Preprogrammed Phone Numbers

When the optional dedicated telephone line is connected to the 1820 system, up to 10 preprogrammed telephone numbers can be stored in the system memory. Preprogrammed telephone numbers can be up to 12 digits in length. These numbers can be called by entering a four-digit code on the lobby panel telephone or the doorman/concierge telephone (see operating instructions). Code must be between 4000 and 9999. Be sure that you do not duplicate doorman/concierge or lobby panel codes (see section 3.2.3).

Factory Default = (Not Programmed)

1. Take the doorman telephone off hook.
2. Press *10 and enter the four-digit MASTER CODE _ _ _ _ (beep).
3. Enter a four-digit directory code (4000-9999) _ _ _ _ then press * (beep).
4. Enter the desired preprogrammed number (12 digits maximum), then press * (beep).
5. Repeat steps 3 – 4 to enter up to 9 preprogrammed numbers.
6. Hang up the doorman telephone to end the programming session.

3.3.3 Erase Preprogrammed Phone Number

This sequence allows you to erase individual preprogrammed phone numbers.

Factory Default = (Not Programmed)

1. Take the doorman telephone off hook.
2. Press *11 and enter the four-digit MASTER CODE _ _ _ _ (beep).
3. Enter the four-digit directory code of the number to be erased (4000-9999) _ _ _ _ then press * (beep).
4. Repeat steps 3 to erase additional numbers.
5. Hang up the doorman telephone to end the programming session.

3.3.4 Erase All Preprogrammed Phone Numbers

This sequence erases all 10 preprogrammed phone numbers.

Factory Default = (Not Programmed)

1. Take the doorman telephone off hook.
2. Press *17 and enter the four-digit MASTER CODE _ _ _ _ (beep).
3. Enter 9 9 9 9 then press * (beep).
4. Hang up the doorman telephone to end the programming session.

3.4 Entry Codes

Entry codes are a four digit number (preceded by #) than can be entered on the Doorman telephone keypad to gain access through the door or gate. When a programmed entry code is entered on the Doorman telephone keypad, the relay on the 1820 control panel will activate for the programmed strike time. The maximum number of entry codes that can be stored in the 1816 memory is 10,000. Use the log sheet provided in the back of this manual to record your entries.

Skip this section if a DoorKing Lobby panel is used. Entry codes will be programmed directly into the lobby panel memory, not the 1820 memory.

3.4.1 Programming Entry Codes

Entry codes can be any four digit combination.

Factory Default = (Not Programmed)

1. Take the doorman telephone off hook.
2. Press *02 and enter the four-digit MASTER CODE _ _ _ _ (beep).
3. Enter a four-digit entry code _ _ _ _ then press * (beep).
4. Repeat step 3 to enter additional entry codes.
5. Hang up the doorman telephone to end the programming session.

3.4.2 Erasing Individual Entry Codes

This sequence allows you to erase an individual entry code (or codes).

Factory Default = (Not Programmed)

1. Take the doorman telephone off hook.
2. Press *06 and enter the four-digit MASTER CODE _ _ _ _ (beep).
3. Enter the four-digit entry code to be erased _ _ _ _ then press * (beep).
4. Repeat step 3 to erase additional entry codes.
5. Hang up the doorman telephone to end the programming session.

3.4.3 Erasing All Entry Codes

This sequence will erase all entry codes that have been programmed into the system.

Factory Default = (Not Programmed)

1. Take the doorman telephone off hook.
2. Press *00 and enter the four-digit MASTER CODE _ _ _ _ (beep).
3. Enter 9 9 9 9 then press * (a long beeeeeep will be heard when complete – about 3 seconds).
4. Hang up the doorman telephone to end the programming session.

3.5 Do Not Disturb Features / Commands

The Do Not Disturb feature provides time zones that prevents calls from the lobby panel to ring up to a resident.

3.5.1 Do Not Disturb Feature On / Off – System Wide

This determines if the system will allow the do not disturb features to be active, or prohibits the do not disturb features from functioning. This is a system wide programming step; either do not disturb features are allowed for all residents or do not disturb features are prohibited for all residents. Turning the do not disturb feature off will not erase any programmed do not disturb time zones.

Factory Default = 0 (Off)

1. Take the doorman telephone off hook.
2. Press *51 and enter the four-digit MASTER CODE _ _ _ _ (beep).
3. Enter 0 to turn do not disturb Off, or enter 1 to turn do not disturb On, then press * (beep).
4. Hang up the doorman telephone to end the programming session.

3.5.2 Set 1-Time Do Not Disturb Timer for Resident(s)

This is a one-time timer that will provide do not disturb for a specific resident for a specific amount of time (1 to 99 hours). Once the timer expires, calls will be allowed to the resident. This is not a schedule; the timer is simply turned on or off for a set period of time and will not repeat itself. The resident may also set this timer from the apartment by using resident commands.

Note: If programmable directory codes are used, enter the directory code number instead of the relay number in step 3.

Factory Default = 0 (Off)

1. Take the doorman telephone off hook.
2. Press *21 and enter the four-digit MASTER CODE _ _ _ _ (beep).
3. Enter the four-digit relay number of the resident the timer is being set for _ _ _ _ then press * (beep). Note: entering 9 9 9 9 in this step will set the timer for all residents.
4. Enter 0 to turn the timer Off, or enter 1 to turn the timer On, then press * (beep). Note: if 0 is selected in this step, go to step 6 to end the programming session.
5. Enter the timer hours (01-99) _ _ then press * (beep).
6. Repeat steps 3-5 to program another resident.
7. Hang up the doorman telephone to end the programming session.

3.5.3 Scheduled Do Not Disturb On / Off

This programming sequence is used by the doorman or system administrator to turn the preprogrammed do not disturb schedule on or off. The resident can also turn this schedule on or off from the apartment using resident commands.

Note: If programmable directory codes are used, enter the directory code number instead of the relay number in step 3.

Factory Default = 0 (Off)

1. Take the doorman telephone off hook.
2. Press *22 and enter the four-digit MASTER CODE ____ (beep).
3. Enter the four-digit relay number of the resident that the schedule is being administered on for ____ then press * (beep). Note: entering 9 9 9 9 in this step will turn the schedule on for all residents.
4. Enter 0 to turn the schedule Off, or enter 1 to turn the schedule On, then press * (beep).
5. Hang up the doorman telephone to end the programming session.

3.5.4 Setting Do Not Disturb Schedule

This programming sequence is used by the doorman or system administrator to set a do not disturb schedule for residents. This schedule must be set by the doorman, it cannot be set by the resident from the resident's apartment.

Note: If programmable directory codes are used, enter the directory code number instead of the relay number in step 3.

Factory Default = 12:00 AM to 6:00 AM Sunday through Saturday

1. Take the doorman telephone off hook.
2. Press *23 and enter the four-digit MASTER CODE ____ (beep).
3. Enter the four-digit relay number of the resident that the schedule is being set for ____ then press * (beep). Note: entering 9 9 9 9 in this step will set the schedule on for all residents.
4. Enter the beginning time in hours and minutes (HHMM) ____ then press * (beep).
5. Enter 0 for AM, or 1 for PM _ then press * (beep).
6. Enter the ending time in hours and minutes (HHMM) ____ then press * (beep).
7. Enter 0 for AM, or 1 for PM _ then press * (beep).
8. Enter the days of the week that the schedule will be active (Sunday = 1; Saturday = 7) then press * (beep). Note: you can enter from 1 – 7 digits in this step. For example, if the schedule is set for Monday, Wednesday and Friday, enter 2 4 6.
9. Repeat steps 3-8 to program another resident.
10. Hang up the doorman telephone to end the programming session.

3.6 Call Forwarding Features / Commands

The Call Forwarding feature provides options that can forward lobby panel calls for a resident to a forwarding number. There are several options available on how a call is forwarded and system administrators should review all these options.

3.6.1 Set Up for Call Forwarding - System Wide

This determines how the call forwarding feature will function system wide. Four options are available:

0. Call forwarding is turned off.
1. Calls from the lobby panel to a resident are forwarded through the phone line connected to the 1820 main control panel.
2. Calls from the lobby panel to a resident are forwarded through the phone line connected to the 1820 main control panel but are restricted to preset area codes.
3. Calls from the lobby panel to a resident are forwarded through the resident's own phone line.

Factory Default = 0 (Off)

1. Take the doorman telephone off hook.
2. Press *45 and enter the four-digit MASTER CODE _ _ _ _ (beep).
3. Enter 0 or 1 or 2 or 3 _ then press * (beep).
4. Hang up the doorman telephone to end the programming session.

3.6.2 Call Forwarding On / Off per Resident

This programming sequence is used by the doorman or system administrator to turn call forwarding on or off per resident. The resident can also turn call forwarding on or off from the apartment using resident commands.

Note: If programmable directory codes are used, enter the directory code number instead of the relay number in step 3.

Factory Default = 0 (Off)

1. Take the doorman telephone off hook.
2. Press *39 and enter the four-digit MASTER CODE _ _ _ _ (beep).
3. Enter the four-digit relay number of the resident that call forwarding is being administered for _ _ _ _ then press * (beep). Note: entering 9 9 9 9 in this step will turn call forwarding on for all residents.
4. Enter 0 to turn call forwarding Off, or enter 1 to turn call forwarding On, then press * (beep).
5. Repeat steps 3 and 4 to program additional residents.
6. Hang up the doorman telephone to end the programming session.

3.6.3 Program Call Forward Numbers

This programming sequence is used by the doorman or system administrator to program call forward numbers for residents. If option 2 was selected in 3.6.1, then the area code will be checked to see if it is allowable or not. If not allowed, the system will ring the resident's phone. The resident can also program the call forwarding number from the apartment.

Note: If programmable directory codes are used, enter the directory code number instead of the relay number in step 3.

Factory Default = (Not Programmed)

1. Take the doorman telephone off hook.
2. Press *40 and enter the four-digit MASTER CODE ____ (beep).
3. Enter the four-digit relay number of the resident that call forward number is being programmed for ____ then press * (beep).
4. Enter the call forward phone number (1 to 12 digits) then press * (beep).
5. Repeat steps 3 and 4 to program additional resident call forward numbers.
6. Hang up the doorman telephone to end the programming session.

3.6.4 Delete Call Forward Numbers

This programming sequence is used by the doorman or system administrator to delete call forward numbers for residents.

Note: If programmable directory codes are used, enter the directory code number instead of the relay number in step 3.

Factory Default = (Not Programmed)

1. Take the doorman telephone off hook.
2. Press *49 and enter the four-digit MASTER CODE ____ (beep).
3. Enter the four-digit relay number of the resident that call forward number is being deleted for ____ then press * (beeeeeep). Note: entering 9 9 9 9 in this step will delete call forwarding numbers for all residents. This command can take as long as 20 seconds to complete. During the erasing process, short beeps will be heard. When all call forwarding numbers are erased, a long beep will be heard.
4. Hang up the doorman telephone to end the programming session.

3.6.5 Program Call Forward Allowed Area Codes

This programming sequence is used by the doorman or system administrator to limit which area codes can be called when option 2 is selected in 3.6.1. This is a feature to prevent toll charges being incurred on calls forwarded through the phone line connected directly to the 1820 control panel. If a call forwarding area code does not match an area code programmed here, then the call is routed to the resident's phone. Up to 30 area codes can be stored in the 1820 memory. A long beep is heard when the memory is full.

Factory Default = (Not Programmed)

1. Take the doorman telephone off hook.
2. Press *46 and enter the four-digit MASTER CODE _ _ _ _ (beep).
3. Enter a three-digit area code _ _ _ then press * (beep).
4. Repeat step 3 to program additional area codes.
5. Hang up the doorman telephone to end the programming session.

3.6.6 Delete Call Forward Allowed Area Codes

This programming sequence is used by the doorman or system administrator to delete area codes from the allowed area code memory.

Factory Default = (Not Programmed)

1. Take the doorman telephone off hook.
2. Press *47 and enter the four-digit MASTER CODE _ _ _ _ (beep).
3. Enter a three-digit area code _ _ _ then press * (beep).
4. Repeat step 3 to delete additional area codes.
5. Hang up the doorman telephone to end the programming session.

3.6.7 Delete All Call Forward Allowed Area Codes

This programming sequence is used by the doorman or system administrator to delete all area codes from the allowed area code memory.

Factory Default = (Not Programmed)

1. Take the doorman telephone off hook.
2. Press *48 and enter the four-digit MASTER CODE _ _ _ _ (beep).
3. Enter 9 9 9 9 then press * (beeeeeep). This process takes about 3 seconds to complete.
4. Hang up the doorman telephone to end the programming session.

3.7 Virtual Doorman

The virtual doorman is an independent system that provides communication from the lobby area to a company that provides doorman services. The virtual doorman service is completely separate from the 1820 system and does not utilize the 1820 lobby panel or any communication circuits provided by the 1820 system.

When virtual doorman service is active and a call is initiated from the 1820 lobby panel, the 1820 will provide a dry relay contact to the virtual doorman system to activate the virtual doorman system. At the same time, the 1820 will disconnect the lobby panel and hang up. The virtual doorman equipment will provide all communication and door access for visitors.

3.7.1 Virtual Doorman On / Off – System Wide

This programming sequence is used by the doorman or system administrator to turn the virtual doorman function On or Off and sets the 1885 on board relay to function as a virtual doorman relay or a door strike relay.

Factory Default = 0 (Off)

1. Take the doorman telephone off hook.
2. Press *52 and enter the four-digit MASTER CODE _ _ _ _ (beep).
3. Enter 0 to turn virtual doorman Off, or enter 1 to turn virtual doorman On, then press * (beep).
4. Hang up the doorman telephone to end the programming session.

3.7.2 Set Virtual Doorman Relay Strike Time

This programming sequence is used by the doorman or system administrator to set the strike time for the virtual doorman activation relay. Strike time can be set from 1 to 99 seconds.

Factory Default = 01

1. Take the doorman telephone off hook.
2. Press *53 and enter the four-digit MASTER CODE _ _ _ _ (beep).
3. Enter a two-digit strike time (01-99) _ _ then press * (beep).
4. Hang up the doorman telephone to end the programming session.

3.7.3 Virtual Doorman On / Off per Resident

This programming sequence is used by the doorman or system administrator to turn virtual doorman On or Off for each resident or for all residents. Entering 9 9 9 9 in this step will turn this feature on or off for ALL residents. Resident's can turn this on or off from the apartment using resident commands.

Note: If programmable directory codes are used, enter the directory code number instead of the relay number in step 3.

Factory Default = 0 (Off)

1. Take the doorman telephone off hook.
2. Press *43 and enter the four-digit MASTER CODE _ _ _ _ (beep).
3. Enter the four-digit relay number of the resident that virtual doorman is being administered for _ _ _ _ then press * (beep).
4. Enter 0 to turn virtual doorman Off, or enter 1 to turn virtual doorman On then press * (beep).
5. Repeat steps 3 and 4 to administer virtual doorman for other residents.
6. Hang up the doorman telephone to end the programming session.

3.8 Call-Down Features / Commands

The call-down feature in the 1820 allows resident's to contact the doorman / concierge directly from their apartment phone without having to dial a 7-digit phone number. It also provides residents with various programming options that they can control directly from their apartment. There are two modes of operation for the "Call-Down" feature.

- **Direct Connect:** In this mode, a resident can call down to the Doorman and be connected directly with the Doorman telephone. The Doorman simply answers the phone to speak with the resident.
- **Call Back Mode:** In this mode, the resident will call the Doorman and the call will automatically be placed on a queue. The resident information is shown on the caller ID display of the Doorman telephone. The Doorman then calls back the resident when he is available. The system will automatically enter this mode when the Doorman phone is busy or if the system is busy (another call in progress). The Doorman may also have the option of putting the system into this mode either temporarily with a timer, or with an On / Off command.

3.8.1 Call-Down Feature On / Off – System Wide

This determines if the system will allow the call-down features to be active, or prohibits the call-down features from functioning. This is a system wide programming step; either the call-down features are allowed for all residents or the call-down features are prohibited for all residents.

Factory Default = 1 (On)

1. Take the doorman telephone off hook.
2. Press *32 and enter the four-digit MASTER CODE _ _ _ _ (beep).
3. Enter 0 to turn call-down Off, or enter 1 to turn call-down On, then press * (beep).
4. Hang up the doorman telephone to end the programming session.

3.8.2 Set Doorman to Enable / Disable Direct Connect

This determines if the Doorman has the ability to enable and disable the Direct Connect Call-Down function. If set to allow the Doorman to enable and disable the Direct Connect feature, this programming step will also determine if the disable function is timer based (see 3.8.3) or is set for an On / Off function.

Factory Default = 1 (Doorman disable is allowed), 0 (Disable timer is OFF)

1. Take the doorman telephone off hook.
2. Press *34 and enter the four-digit MASTER CODE _ _ _ _ (beep).
3. Enter 0 (Doorman CANNOT disable Direct Connect), or enter 1 (Doorman CAN disable Direct Connect), then press * (beep).
4. Enter 0 for the Doorman disable to be toggle based (On / Off), or enter 1 for the Doorman disable to be timer based, then press * (beep).
5. Hang up the doorman telephone to end the programming session.

3.8.3 Set Direct Connect Disable Timer

If Doorman disable is allowed and the disable timer is On (see 3.8.2), then this programming step will set the amount of time for the disable timer. When the timer expires, Direct Connect is restored. The disable timer can be set from 1 (01) to 99 (99) minutes.

Factory Default = 30 (30 minutes)

1. Take the doorman telephone off hook.
2. Press *35 and enter the four-digit MASTER CODE _ _ _ _ (beep).
3. Enter a two-digit disable time (in minutes) _ _ , then press * (beep).
4. Hang up the doorman telephone to end the programming session.

3.8.4 Set Direct Connect Call-Down Number

This programming step sets the 1-digit number that the resident will use to call down to the Doorman / Concierge telephone. The call-down number can be set from 0 – 9. Do not duplicate the 1-digit resident programming number (see 3.8.5).

Factory Default = 7

1. Take the doorman telephone off hook.
2. Press *37 and enter the four-digit MASTER CODE _ _ _ _ (beep).
3. Enter the one-digit Direct Connect number _ then press * (beep).
4. Hang up the doorman telephone to end the programming session.

3.8.5 Set Resident Programming Number

This programming step sets the 1-digit number that the resident will use to enter a programming mode to set various functions. The programming number can be set from 0 – 9. Do not duplicate the 1-digit resident Direct Connect number (see 3.8.4).

Factory Default = 8

1. Take the doorman telephone off hook.
2. Press *38 and enter the four-digit MASTER CODE _ _ _ _ (beep).
3. Enter the one-digit Direct Connect number _ then press * (beep).
4. Hang up the doorman telephone to end the programming session.

SECTION 4 – OPERATING INSTRUCTIONS

4.1 Administrator and Doorman Commands & Functions

These commands are used by the System Administrator, Doorman, Concierge or Security Desk to access various features of the 1820 system.

4.1.1 Lobby Panel On / Off

This programming sequence is used by the doorman or system administrator to turn the lobby panel On or Off.

Factory Default = 1 (On)

1. Take the doorman telephone off hook.
2. Press *12 and enter the four-digit MASTER CODE ____ (beep).
3. Enter 0 to turn the lobby panel Off, or enter 1 to turn the lobby panel On, then press * (beep).
4. Hang up the doorman telephone to end the programming session.

4.1.2 Calling the Lobby Panel

This programming sequence is used by the doorman or system administrator to place a call to the lobby panel from the doorman telephone.

1. Take the doorman telephone off hook.
2. Enter the four-digit lobby panel directory code programmed in section 3.2.3.
3. The lobby panel will answer.
 - a. If a DoorKing 1830 series or “P” series lobby panel is used, the lobby panel will answer with a 1 second tone. Once the tone is heard, press *16 and then enter the four-digit lobby panel MASTER CODE _____. This will open communication between the lobby panel and doorman phone.
4. Hang up the doorman telephone to disconnect from the lobby panel.

4.1.3 Accessing the Outside Phone Line

A dedicated C.O. phone line must be connected to the 1820 control panel for this feature to be operable.

1. Take the doorman telephone off hook.
2. Enter the four-digit outside line access code that was programmed in section 3.3.1. The outside line dial tone will be heard allowing calls to be made.

4.1.4 Calling Preprogrammed Telephone Numbers

A dedicated C.O. phone line must be connected to the 1820 control panel for this feature to be operable. Preprogrammed telephone numbers can be called from either the Doorman phone or the lobby panel.

1. From either the lobby panel or doorman phone, enter the four digit access code of the preprogrammed phone number you want to call. Refer to section 3.3.2.

4.1.5 Calling the Doorman or Lobby Panel from an Off Site Location

A dedicated C.O. phone line must be connected to the 1820 control panel for this feature to be operable. This feature allows managers to place a call to the Doorman or lobby panel from an off site location.

To call the doorman phone:

1. Call the phone number of the C.O. line attached to the 1820 system. The 1820 will answer with a short tone (beep).
2. Press #1 to be connected to the doorman phone.
3. The doorman phone will ring until it is picked up OR until the number of rings programmed in section 3.1.7 is met.

To call the lobby panel:

1. Call the phone number of the C.O. line attached to the 1820 system. The 1820 will answer with a short tone (beep).
2. Press #2 to be connected to the lobby panel.
 - a. If a DoorKing 1800 series, 1830 series or "P" series lobby panel is used, the lobby panel will answer with a 1 second tone. Once the tone is heard, press *16 and then enter the four-digit lobby panel MASTER CODE _ _ _ _ . This will open communication to the lobby panel.

4.1.6 Lobby Panel Relay Activation

A dedicated C.O. phone line must be connected to the 1820 control panel for this feature to be operable. This feature can only be used with DoorKing lobby panels.

1. Call the phone number of the C.O. line attached to the 1820 system. The 1820 will answer with a short tone (beep).
2. Press #2 to be connected to the lobby panel.
3. The lobby panel will answer with a 1 second tone. Once the tone is heard, press *16 and then enter the four-digit lobby panel MASTER CODE _ _ _ _ . This will open communication to the lobby panel.
4. Press "9" (or the number that has been programmed in the lobby panel to open the door).

4.1.7 Calling a Resident without C.O. Phone Service from an Off Site Location

A dedicated C.O. phone line must be connected to the 1820 control panel for this feature to be operable. This feature allows managers to place a call to residents who do not have C.O. phone service from an off site location.

1. Call the phone number of the C.O. line attached to the 1820 system. The 1820 will answer with a short tone (beep).
2. Press #3 and enter the resident's four digit directory code. The 1820 will connect to the resident's phone.

4.1.8 Turn Direct Connect On / Off

This command allows the Doorman to disable the resident direct connect call down feature. When disabled, this feature is either timer based or can be toggled On or Off by the Doorman depending on the programming in 3.8.2. When direct connect is disabled, the system will function in "Call Back" mode.

In Call Back mode, the resident's call is placed in the call back queue in the order that it was received. The resident's relay number or directory code for the first resident in queue is shown on the Doorman caller ID display (the display also shows the number of calls in the queue) allowing the Doorman to call back the resident (see 4.1.9) when he/she has time. When the call is completed (Doorman phone hangs up), the next call in queue will ring at the Doorman phone. This pattern will continue until all calls in the queue are exhausted or the Doorman clears the queue (see 4.1.10). Up to 50 resident calls can be held in the queue.

1. Take the doorman telephone off hook.
2. Press *30 (beep).
3. Enter 0 to disable direct connect call-down, or enter 1 to enable direct connect call-down, then press * (beep).
4. Hang up the doorman telephone to end the programming session.

4.1.9 Call Back a Resident

When a resident call is in the call-down queue, the system will ring the Doorman telephone and show the resident's relay number or directory code on the caller ID display. The Doorman can then call back the resident shown on the display.

1. Take the doorman telephone off hook.
2. Press *69.
3. The system will call the first resident in the call down queue. The Doorman can also dial the resident's relay number or directory code to call the resident.

4.1.10 Clear Call Back Number or Queue

This command allows the Doorman to clear a particular call back number in the queue, or he/she can clear the entire queue.

1. Take the doorman telephone off hook.
2. Press *85 and enter the four-digit relay number or directory code to be cleared _ _ _ _ then press * (beep). Note: entering 9 9 9 9 in this step will clear all entries from the queue.
3. Hang up when complete.

4.2 Technician Commands

The following commands should be used by trained technicians only and are designed for trouble shooting purposes.

4.2.1 Reset Main Control Board

This programming sequence will reset the 1885 main control board to the factory default values. This function will take about 5 minutes to complete.

1. Take the doorman telephone off hook.
2. Press *91 and enter the four-digit MASTER CODE _ _ _ _ (beep).
3. Enter 9 9 9 9 then press * (beep).
4. Hang up the doorman telephone to end the programming session.

Function	Section	Default	Description
54	3.1.2	0	1882 Relay boards
07	3.1.3	0011	Highest available relay
41	3.1.5	1234567890	Caller ID default number
08	3.1.6	60	Talk time in seconds
04	3.1.7	5,2	5 rings, double ring
05	3.1.8	9876	Relay tone numbers
03	3.1.9	01	Relay strike time
13	3.2.2	1	Programmable directory codes OFF
09	3.3.1	FFFF	Outside line access code not programmed
51	3.5.1	0	Do not disturb OFF
45	3.6.1	0	Call forwarding OFF
52	3.7.1	0	Virtual doorman OFF
53	3.7.2	01	Virtual doorman relay strike time
32	3.8.1	0	Call-Down OFF system wide
34	3.8.2	1,0	Doorman call-down control ON, call-down timer OFF
35	3.8.3	30	Call-down disable timer in seconds
37	3.8.4	7	Resident direct connect call-down number
38	3.8.5	8	Resident programming number
12	4.1.1	1	Lobby panel ON
42	4.2.3	05	Touch-tone detect time in seconds

4.2.2 Reset Main Control Board Resident Programming

This programming sequence will reset the programming specific to each resident to the 1885 main control board factory default values. This function will take about 5 minutes to complete. The power LED on the main control board will flash during the process. The LED becomes steady ON when completed.

NOTE: This command will perform command function 91 (4.2.1) automatically.

1. Take the doorman telephone off hook.
2. Press *90 and enter the four-digit MASTER CODE _ _ _ _ (beep).
3. Enter 9 9 9 9 then press * (beep).
4. Hang up the doorman telephone to end the programming session.

Function	Section	Default	Description
18	3.2.3		Turns off doorman / lobby call option
15	3.2.4		Delete all directory code programming
11	3.3.3		Delete all preprogrammed phone numbers
00	3.4.3		Delete all entry codes
21	3.5.2	0	Do not disturb timer OFF
22	3.5.3	0	Scheduled do not disturb OFF
23	3.5.4		Scheduled do not disturb set to 12:00 AM – 06:00 AM Sunday - Saturday
39	3.6.2	0	Call forward OFF
49	3.6.4		Delete all call forwarding numbers
48	3.6.7		Delete all area code programming
43	3.7.3	0	Virtual doorman OFF

4.2.3 Set Touch-Tone Detect Time

This sets the time that the Line Interface Board will “listen” for the touch-tone numbers programmed in 3.8.4 and 3.8.5 after the resident takes their phone “off-hook.” The Line Interface Board has one tone decoder which is shared between the 12 residents connected to the board. After the timer expires, the board will reset and wait for another “off-hook” line.

Factory Default = 05 (5 seconds)

1. Take the doorman telephone off hook.
2. Press *42 and enter the four-digit MASTER CODE _ _ _ _ (beep).
3. Enter the two-digit touch-tone detect time (in seconds) _ _ then press * (beep).
4. Hang up the doorman telephone to end the programming session.

4.2.4 Reset Line Interface Board Programming

This programming step will reset the Line Interface Boards to their default values.

Defaults

Resident Direct Connect Number (3.8.4) = 7

Resident Programming Number (3.8.5) = 8

Touch-Tone Detect Timer (4.2.3) = 05 (5 seconds)

1. Take the doorman telephone off hook.
2. Press *57 and enter the four-digit MASTER CODE _ _ _ _ (beep).
3. Enter 9 9 9 9 then press * (beep).
4. Hang up the doorman telephone to end the programming session.

4.2.5 Send Software Reset to All Line Interface Boards

This will re-initialize all Line Interface Boards.

1. Take the doorman telephone off hook.
2. Press *58 and enter the four-digit MASTER CODE _ _ _ _ (beep).
3. Enter 9 9 9 9 then press * (beep).
4. Hang up the doorman telephone to end the programming session.

Appendix

You can use these tables to help organize some of the programmed features of the 1816 system. Make copies of the table on the next page to help organize resident information.

Make copies of the RJ71C Forms as they will be needed when installing these phone blocks. RJ71C forms are available in electronic format on our tech support web-site at www.dkaccess.com.

You may also copy the Resident Instruction Sheet. Just fill in the blanks.

Programming Section	Description	Code Programmed*
3.2.3	Directory code for Doorman/Concierge phone.	
3.3.1	Outside line access code for Doorman/Concierge.	
3.3.2	Preprogrammed Phone Number 1	
	Preprogrammed Phone Number 2	
	Preprogrammed Phone Number 3	
	Preprogrammed Phone Number 4	
	Preprogrammed Phone Number 5	
	Preprogrammed Phone Number 6	
	Preprogrammed Phone Number 7	
	Preprogrammed Phone Number 8	
	Preprogrammed Phone Number 9	
	Preprogrammed Phone Number 10	

* Programmed directory or access codes must be between 4000 and 9999.

RJ71C / Relay Board Identification
Model 1820 Main Garden Style (Small) Cabinet

RJ71C Board #	Phone Number	RJ71C Pins Input/Output	Apt Number	Dir Code	Relay Number
3		1,2 / 27,28			00
		3,4 / 29,30			01
		5,6 / 31,32			02
		7,8 / 33,34			03
		9,10 / 35,36			04
		11,12 / 37,38			05
		13,14 / 39,40			06
		15,16 / 41,42			07
		17,18 / 43,44			08
		19,20 / 45,46			09
		21,22 / 47,48			10
		23,24 / 49,50			11
RJ71C Board #	Phone Number	RJ71C Pins Input/Output	Apt Number	Dir Code	Relay Number
2		1,2 / 27,28			00
		3,4 / 29,30			01
		5,6 / 31,32			02
		7,8 / 33,34			03
		9,10 / 35,36			04
		11,12 / 37,38			05
		13,14 / 39,40			06
		15,16 / 41,42			07
		17,18 / 43,44			08
		19,20 / 45,46			09
		21,22 / 47,48			10
		23,24 / 49,50			11
RJ71C Board #	Phone Number	RJ71C Pins Input/Output	Apt Number	Dir Code	Relay Number
1		1,2 / 27,28			00
		3,4 / 29,30			01
		5,6 / 31,32			02
		7,8 / 33,34			03
		9,10 / 35,36			04
		11,12 / 37,38			05
		13,14 / 39,40			06
		15,16 / 41,42			07
		17,18 / 43,44			08
		19,20 / 45,46			09
		21,22 / 47,48			10
		23,24 / 49,50			11
RJ71C Board #	Phone Number	RJ71C Pins Input/Output	Apt Number	Dir Code	Relay Number
0		1,2 / 27,28			00
		3,4 / 29,30			01
		5,6 / 31,32			02
		7,8 / 33,34			03
		9,10 / 35,36			04
		11,12 / 37,38			05
		13,14 / 39,40			06
		15,16 / 41,42			07
		17,18 / 43,44			08
		19,20 / 45,46			09
		21,22 / 47,48			10
		23,24 / 49,50			11

**RJ71C / Relay Board Identification
Model 1820 Main (Large) Cabinet**

RJ71C Board #	Phone Number	RJ71C Pins Input/Output	Apt Number	Dir Code	Relay Number
2		1,2 / 27,28			00
		3,4 / 29,30			01
		5,6 / 31,32			02
		7,8 / 33,34			03
		9,10 / 35,36			04
		11,12 / 37,38			05
		13,14 / 39,40			06
		15,16 / 41,42			07
		17,18 / 43,44			08
		19,20 / 45,46			09
		21,22 / 47,48			10
		23,24 / 49,50			11
RJ71C Board #	Phone Number	RJ71C Pins Input/Output	Apt Number	Dir Code	Relay Number
1		1,2 / 27,28			00
		3,4 / 29,30			01
		5,6 / 31,32			02
		7,8 / 33,34			03
		9,10 / 35,36			04
		11,12 / 37,38			05
		13,14 / 39,40			06
		15,16 / 41,42			07
		17,18 / 43,44			08
		19,20 / 45,46			09
		21,22 / 47,48			10
		23,24 / 49,50			11
RJ71C Board #	Phone Number	RJ71C Pins Input/Output	Apt Number	Dir Code	Relay Number
0		1,2 / 27,28			00
		3,4 / 29,30			01
		5,6 / 31,32			02
		7,8 / 33,34			03
		9,10 / 35,36			04
		11,12 / 37,38			05
		13,14 / 39,40			06
		15,16 / 41,42			07
		17,18 / 43,44			08
		19,20 / 45,46			09
		21,22 / 47,48			10
		23,24 / 49,50			11

RJ71C / Relay Board Identification Model 1820 (Large) Auxiliary Cabinet							<u>Cabinet No.</u>				
--	--	--	--	--	--	--	---------------------------	--	--	--	--

RJ71C Board #	Phone Number	RJ71C Pins Input/Output	Apt Number	Dir Code	Relay Number	RJ71C Board #	Phone Number	RJ71C Pins Input/Output	Apt Number	Dir Code	Relay Number
		1,2 / 27,28			00			1,2 / 27,28			00
		3,4 / 29,30			01			3,4 / 29,30			01
		5,6 / 31,32			02			5,6 / 31,32			02
		7,8 / 33,34			03			7,8 / 33,34			03
		9,10 / 35,36			04			9,10 / 35,36			04
		11,12 / 37,38			05			11,12 / 37,38			05
		13,14 / 39,40			06			13,14 / 39,40			06
		15,16 / 41,42			07			15,16 / 41,42			07
		17,18 / 43,44			08			17,18 / 43,44			08
		19,20 / 45,46			09			19,20 / 45,46			09
		21,22 / 47,48			10			21,22 / 47,48			10
		23,24 / 49,50			11			23,24 / 49,50			11
		1,2 / 27,28			00			1,2 / 27,28			00
		3,4 / 29,30			01			3,4 / 29,30			01
		5,6 / 31,32			02			5,6 / 31,32			02
		7,8 / 33,34			03			7,8 / 33,34			03
		9,10 / 35,36			04			9,10 / 35,36			04
		11,12 / 37,38			05			11,12 / 37,38			05
		13,14 / 39,40			06			13,14 / 39,40			06
		15,16 / 41,42			07			15,16 / 41,42			07
		17,18 / 43,44			08			17,18 / 43,44			08
		19,20 / 45,46			09			19,20 / 45,46			09
		21,22 / 47,48			10			21,22 / 47,48			10
		23,24 / 49,50			11			23,24 / 49,50			11
		1,2 / 27,28			00			1,2 / 27,28			00
		3,4 / 29,30			01			3,4 / 29,30			01
		5,6 / 31,32			02			5,6 / 31,32			02
		7,8 / 33,34			03			7,8 / 33,34			03
		9,10 / 35,36			04			9,10 / 35,36			04
		11,12 / 37,38			05			11,12 / 37,38			05
		13,14 / 39,40			06			13,14 / 39,40			06
		15,16 / 41,42			07			15,16 / 41,42			07
		17,18 / 43,44			08			17,18 / 43,44			08
		19,20 / 45,46			09			19,20 / 45,46			09
		21,22 / 47,48			10			21,22 / 47,48			10
		23,24 / 49,50			11			23,24 / 49,50			11

--	--	--	--	--	--	--	--	--	--	--	--

Resident Instructions



Your building has been equipped with a DoorKing Telephone Intercom System that will provide communication for your guest from the lobby door to your home by use of the telephones in your home. If you have any questions regarding the use or operation of this system, please see your system administrator (building manager / HOA representative).

Guest Calls

When a guest calls you from the lobby phone panel, the telephones in your home will ring with one long ring and then continue with two short rings (RING - RING) instead of the standard long ring (R I I I I I I I N G). If you have a telephone with caller ID capability, the number displayed will identify the call as from the lobby panel or the concierge.

- The system administrator may change the double ring default setting to a single ring.
- The caller ID number can be changed by the system administrator.

Granting or Denying Access

To allow your guest access, press “9” on your touch-tone telephone. Some phones emit a very short tone. In these cases, you may have to press 9 twice in rapid succession. To deny a guest access, press the # key and hang-up.

Call Waiting

If you are on an outside call when a guest calls you from the lobby, you will hear a short tone in your telephone handset. Press “3” to place your outside call on hold. The system will automatically connect you with the lobby panel. If you wish to grant your guest access, press “9” on your telephone. The system will unlock the lobby door and automatically switch you back to your outside call. If you wish to deny your guest access, press the “3” key again and the system will switch back to your outside call without unlocking the lobby door.

Call Down to the Doorman / Concierge

The “Direct Connect” call-down is a unique feature of the DoorKing system that allows you to call the Doorman or Concierge by just pressing *7 (star 7) on your touch-tone telephone. If the Doorman does not answer or the system is busy or the Doorman has temporarily disabled the direct connect feature, you will hear three short beeps (beep-beep-beep) in your telephone. If you hear the three beeps, you can hang up. The system will automatically put your call into a call-back queue and the Doorman will return your call when he/she is available.

Access Code

Your system may be equipped with an access code that will allow you to open the lobby door by entering this code on the system keypad. Your system administrator will advise you of your access code if this option is available. To use the access code, first press the # key, and then enter the four digit code.

Resident Advanced Programming Instructions



Call Waiting On / Off

The DoorKing system has a built-in call waiting feature (*see Call Waiting on first page of Resident Instructions*) that you can control in conjunction with the telephone company call waiting service. During normal telephone conversations, you can enter *70 on your telephone to disable the telephone company call waiting feature. When you hang-up, call waiting is reactivated. You can set the DoorKing system to disable its call waiting feature if you disable the telephone companies call waiting (*70), or you can keep the DoorKing call waiting active even if you disable the telephone company call waiting service.

1. From your telephone press *8 (beep). If you don't hear the "beep", the system is busy. Hang up and try again in a minute or two.
2. Press 10* (beep).
3. Enter 0* (beep) to disable the DoorKing call waiting along with the telephone company call waiting when *70 is pressed on your telephone during a call.
OR
Enter 1* (beep) to keep the DoorKing call waiting active even if the telephone company call waiting is disabled.
4. Hang up.

Call Forwarding

The call forwarding feature can automatically forward calls from the lobby to another telephone. You can program the telephone number that you want your calls forwarded to. The system may or may not be programmed to allow calls to certain area codes. If your forwarding number is long distance, you should contact your system administrator to determine if the area code you program is on the allowed area code list.

1. From your telephone press *8 (beep). If you don't hear the "beep", the system is busy. Hang up and try again in a minute or two.
2. Press 11* (beep).
3. Enter 0* (beep) to turn call forwarding Off, OR Enter 1* (beep) to turn call forwarding On. If your call forwarding number is already programmed, hang up. If you need to program a call forwarding number, or change a previously programmed number, proceed to step 4.
4. Enter the call forwarding number (12 digits maximum) then press * (beep).
5. Hang up.

Do Not Disturb Timer

The do-not-disturb timer will prevent calls from the lobby or concierge to your telephone for a specified period of time. This is a “one-time” timer that you set for a specific period of time. Once the time runs out (or you turn the timer off), the timer is reset to 0 and calls are allowed.

1. From your telephone press *8 (beep). If you don't hear the “beep”, the system is busy. Hang up and try again in a minute or two.
2. Press 12* (beep).
3. Enter 0* (beep) to turn the do-not-disturb timer Off, OR Enter 1* (beep) to turn the do-not-disturb timer On. If you are turning the timer off, hang up. If you need to program the do-not-disturb timer duration, proceed to step 4.
4. Enter the timer duration in hours (01-99) then press * (beep).
5. Hang up.

Do Not Disturb Schedule

The do-not-disturb schedule will prevent calls from the lobby or concierge to your telephone during certain hours of the day. The schedule must be programmed by the Doorman (or use the default schedule). This sequence allows you to turn the schedule On or Off. The default do-not-disturb schedule is 12:00 AM to 6:00 AM Sunday through Saturday.

1. From your telephone press *8 (beep). If you don't hear the “beep”, the system is busy. Hang up and try again in a minute or two.
2. Press 13* (beep).
3. Enter 0* (beep) to the do-not-disturb schedule Off, OR Enter 1* (beep) to turn the do-not-disturb schedule On.
4. Hang up.

Virtual Doorman On / Off

A Virtual Doorman is an independent system that provides communication from the lobby area to a service company providing Doorman services. This is completely independent from the DoorKing system. Check with your system administrator or building superintendent to determine if your building uses Virtual Doorman service. This programming sequence allows you to turn the service on or off if your building uses a Virtual Doorman service.

1. From your telephone press *8 (beep). If you don't hear the “beep”, then the system is busy. Hang up and try again in a minute or two.
2. Enter *14 (beep).
3. Enter 0* (beep) to turn the Virtual Doorman service Off for your apartment, OR Enter 1* (beep) to turn the Virtual Doorman service On for your apartment.
4. Hang up.

